

# Kenos® KCS



- ▶ The KCS (Kenos collaborative small gripper) gripping system is equipped with integrated COAX® SX cartridges.
- ▶ The quick change system of KCS allows the gripper to move from one application to another very quickly.
- ▶ The KCS is equipped with a flow restrictor suitable for handling different sized sealed or leaking objects with the same lifting device even if the total foam area is not covered, the KCS will still maintain enough vacuum level to lift the object.
- ▶ The COAX® SX cartridges- providing high performance even at low or fluctuating feed pressures. The KCS can be equipped with 1 or 2 COAX® SX cartridges.

## Technical data

Description	Unit	Value
Feed pressure, max.	MPa	0.7
Temperature range	°C	0-50
Weight	g	625
Material	-	PA, POM, EPDM, SS, NBR, PVC, HDPE
Noise level	dBA	70
Connection, compressed air	-	G 1/8"
Material foam	-	EPDM

### Vacuum flow

Feed pressure pump / nozzle	Air Consumption per pump/nozzle	Vacuum flow (NI/s) at different vacuum levels (-kPa)									Max vacuum	
		0	10	20	30	40	50	60	70	80		-kPa
MPa	NI/s											
0.54 / 0.43	4.42	6.92	6.04	4.82	3.40	2.04	1.22	0.94	0.56	0.20	90	

### Gripping force data

Force, N, at different vacuum levels (-kPa)						
30	40	50	60	70	80	90
81	109	136	163	190	217	244

Dimensional drawing

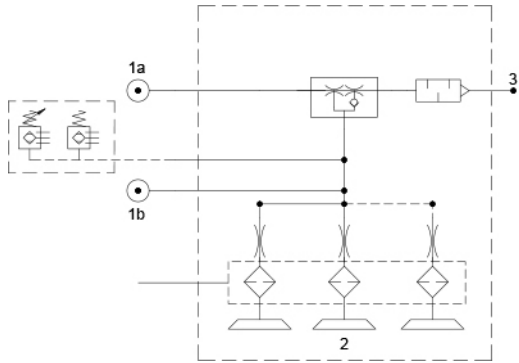

A	110 [4.33"]
B	30 [1.18"]
C	47 [1.85"]

Note: The filter, the monitoring and the valves are optional depending on your configuration.

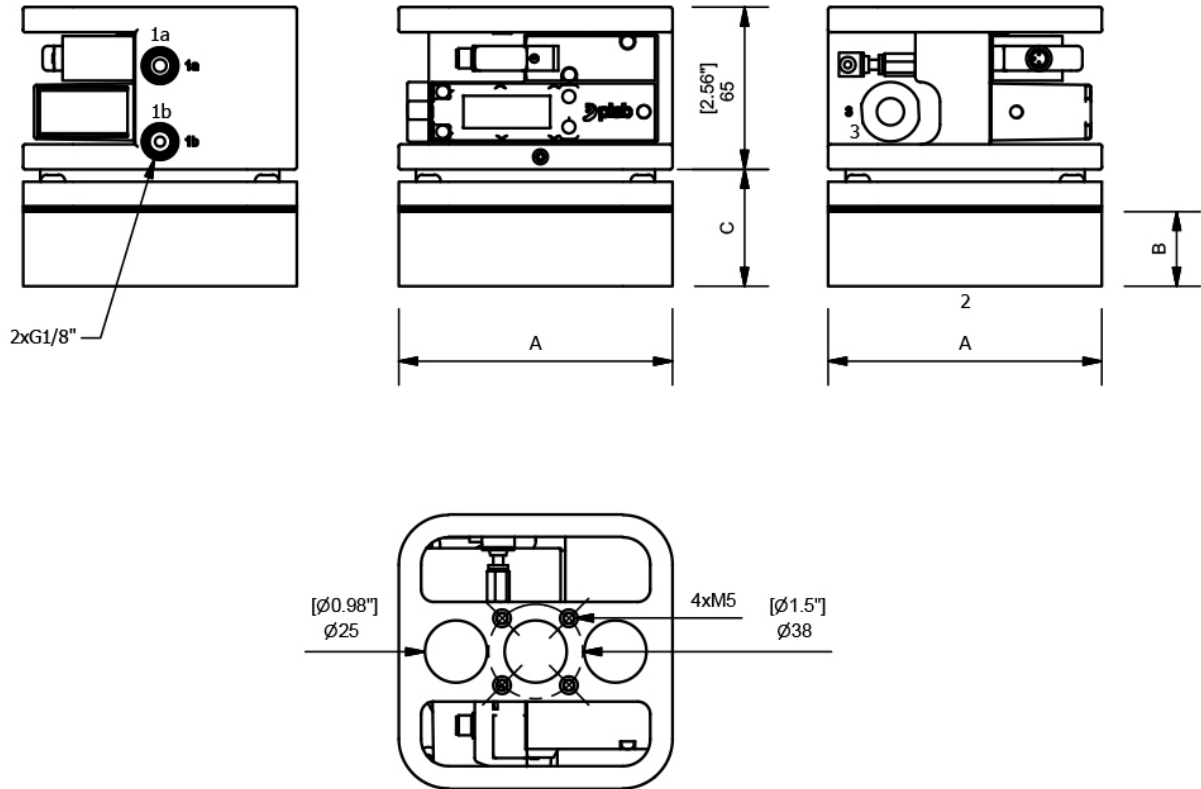

Note: The monitoring and the valves are optional depending on your configuration.

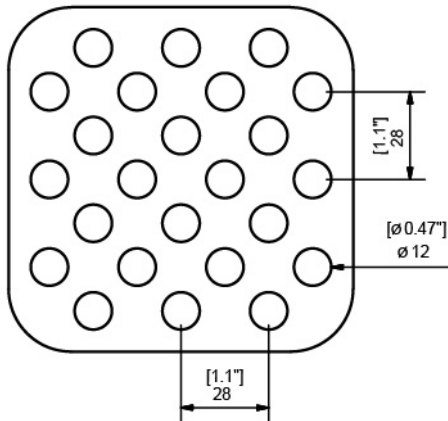

### Ordering information

Description	Product code
KCS 110x110mm, Foam, Foam EPDM, Foam 30mm, With filter, Fine step, 110x110mm, Flow Reduction 0,6 mm (standard), Ejector pump, 2 x SX42, Without solenoid valves, Without vacuum switch or sensor, Without fixing interface	KCS.Q110.N311.110.FR6.SX422.X.X.X

### Ordering information, spare part foam

Description	Product code
Foam EPDM, Foam 30mm, With filter, Fine step, 110x110mm	FOAM.KCS.Q110.N311.110