



Automation for a Changing World

Delta Sensorless Vector Control Compact Drive VFD-E Series



www.deltaww.com

 **DELTA**
Smarter. Greener. Together.

Features

▶ **Modular Design**

Modular structure and extension with optional cards

▶ **Standard MODBUS Protocol**

Standard MODBUS protocol via RS-485

▶ **Built-in EMC Filter (230V single-phase and 460V 3-phase)**

Efficiently reduces electromagnetic interference

▶ **Compact Design**

Space saving and easy DIN rail mounting with optional DIN rail adapter

▶ **Optional Fieldbus Modules**

Provide connection to a variety of networks, including PROFIBUS, DeviceNet and CANopen

▶ **Flexible Extension**

Via optional cards, such as I/O card, Relay card, PG (Encoder) card and USB card, to meet your application requirements



▶ **RFI Switch for IT Mains**

Removable "Y" capacitor to use with IT mains supplies



▶ **Easy DC Bus Sharing**

Multiple VFD-E units can be connected in parallel to share regenerative braking energy. It prevents over-voltage and stabilizes the DC bus voltage

▶ **Complete Protection Functions**

High precision current detection, full overload protection (oL, oL1 and oL2), overvoltage/overcurrent stall prevention, short circuit protection, reset after fault, speed search function and motor overheat protection by PTC

▶ **Removable Keypad**

The standard keypad acts as a status monitor. More functions, including parameter modification, RUN/STOP, speed change, and status display, are available via an optional keypad



▶ **Built-in PLC Function**

PLC programming and editing capability without the need of an actual PLC

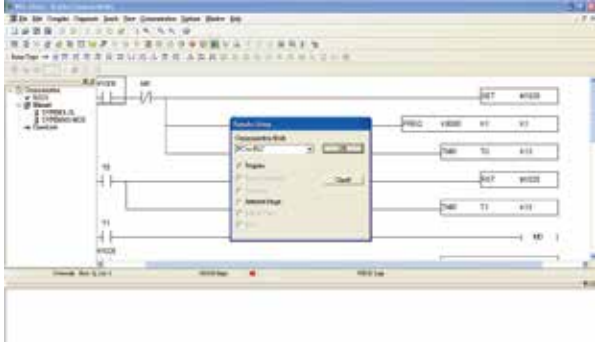

▶ **Side-by-side Installation (40°C)**

High-efficiency cooling and flexible spacing



▶ **Power Range**

Single-phase 115 V series: 0.2~0.75 kW (0.25~1 hp)
Single-phase 230 V series: 0.2~2.2 kW (0.25~3 hp)
3-phase 230 V series: 0.2~15 kW (0.25~20 hp)
3-phase 460 V series: 0.4~22 kW (0.50~30 hp)

▶ **Easy Maintenance**

Removable cooling fan for easy maintenance



▶ **Applications**

▶ **Vacuum compressor**

Outstanding overload capability of VFD-E reduces the impact of sudden load increase to the vacuum compressor

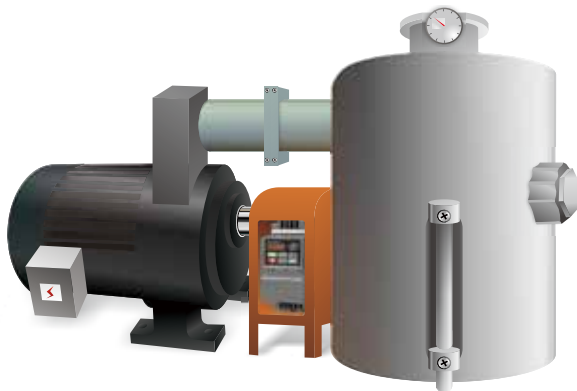

▶ **Escalator**

Built-in PLC function and multi-step speed control provide energy saving escalator performance and save the cost of purchasing a host controller

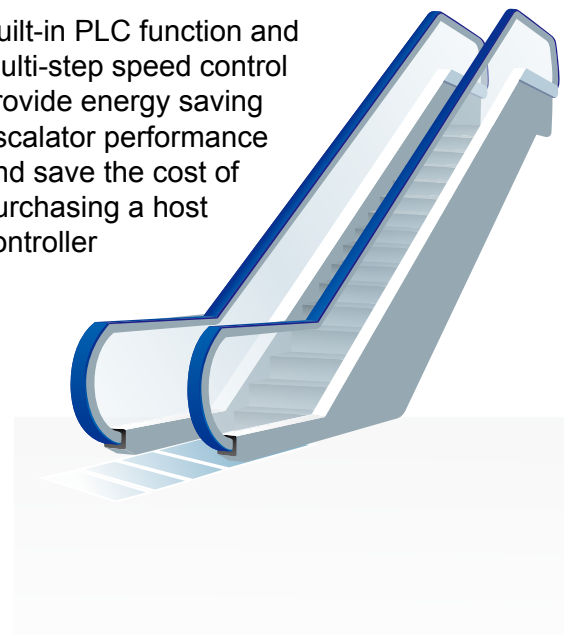

Standard Wiring Diagram

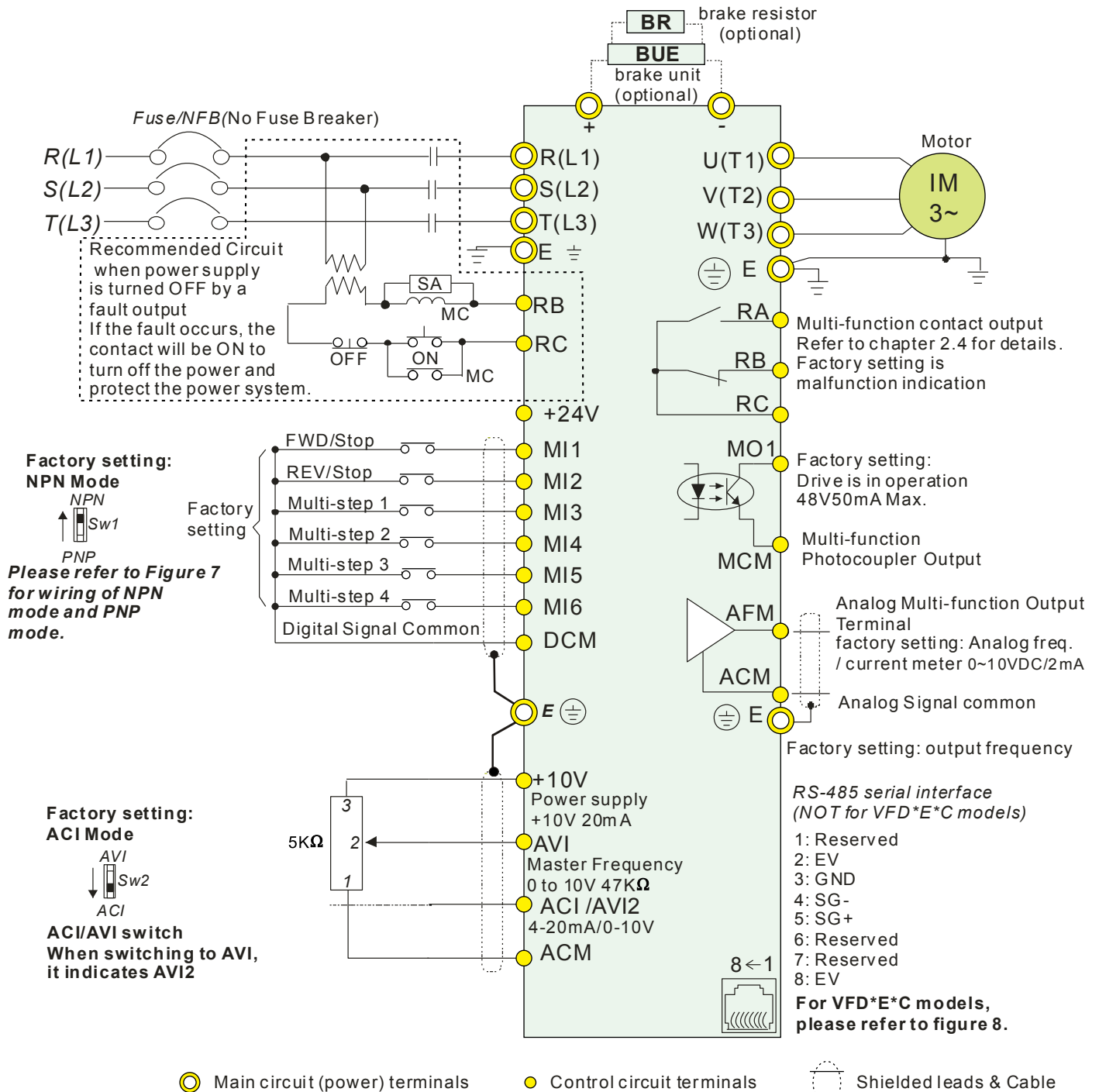

NOTE

It is recommended to install a circuit breaker at the control terminal to protect the circuit from an operation abnormality or sudden power outage.

The protection circuit uses the multi-function output terminal of the AC motor drive for connection. When an abnormal condition (closed contact) occurs, the external power supply is disconnected to protect the power system of the AC motor drive.

External Parts

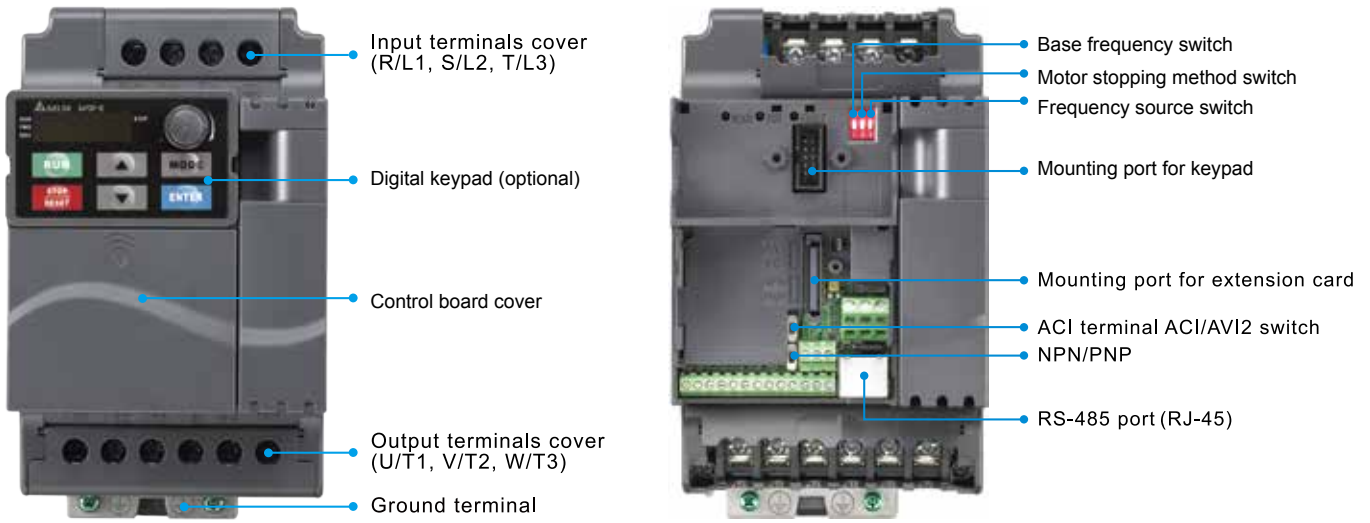

Control Terminals

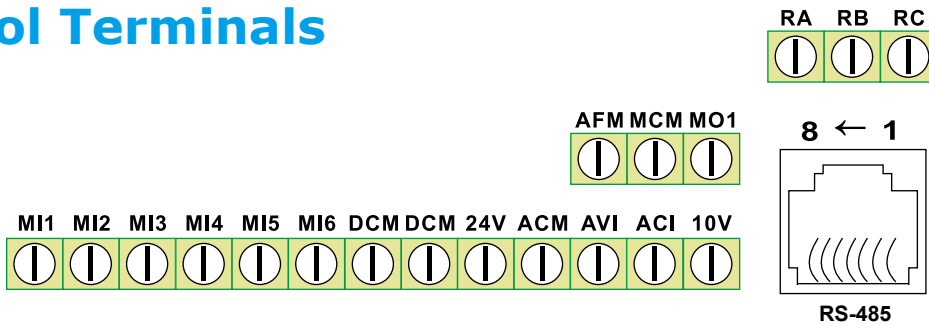

Model Explanation

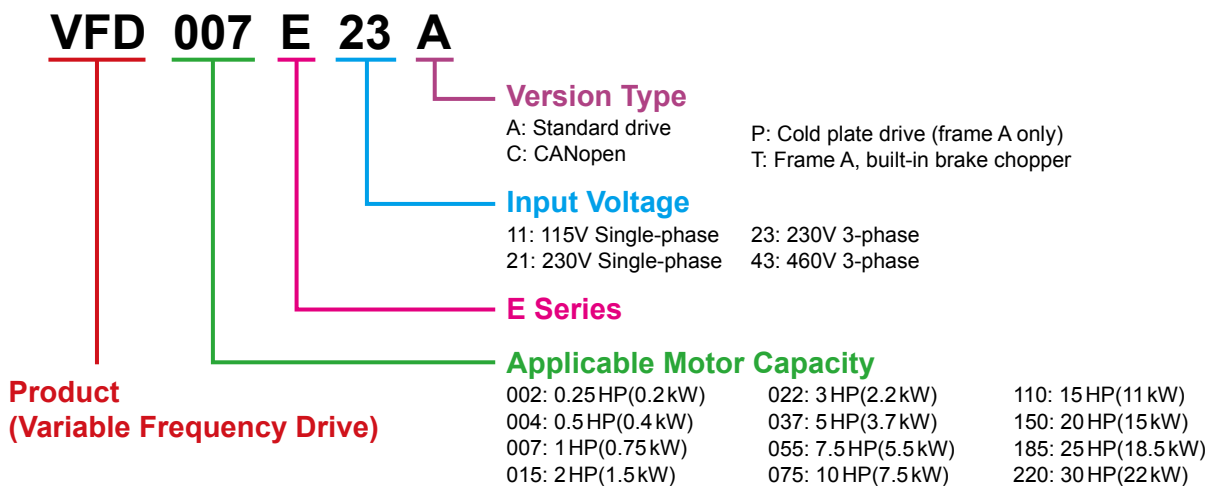

Application Fields

Conveyor and Transportation Machinery

- Conveyor belt
- Automatic door
- Roller door
- Small elevator
- Escalator
- X-Y axis traveling crane

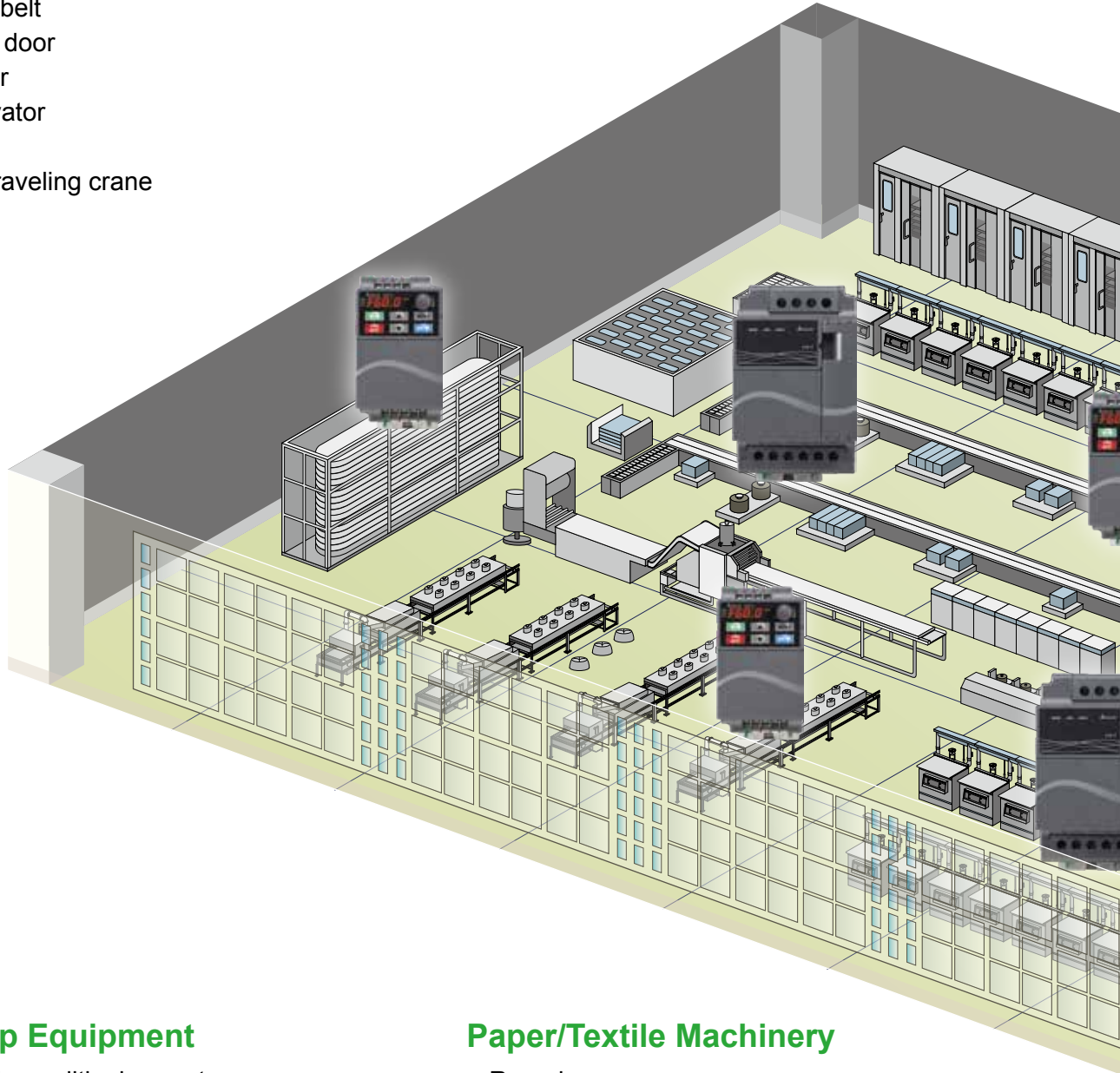

Fan/Pump Equipment

- Building air conditioning system
- Wastewater processing system
- Constant pressure water treatment system
- Water treatment pump
- Agricultural pump
- Temperature control of mid and larger oven
- Air compressor
- Heat exchange fan
- Building water dispenser system
- Dryer's windmill

Paper/Textile Machinery

- Round weaver
- Cross weaver
- Ribbon weaver
- Printing press
- Industrial sewing machine
- Knitting machine

Food Processing

- Dumpling making machine
- Food mixer
- Noodle making machine

Wood Working Machinery

- 4 side planer
- Wood carving machine
- Woodworking machine
- Simple cutting machine for wood working
- Spraying machine

Machine Tool/Metal Processing Machinery

- Grinding machine
- Drilling machine
- Small lathe
- Milling machine
- Injection molding (clamp)

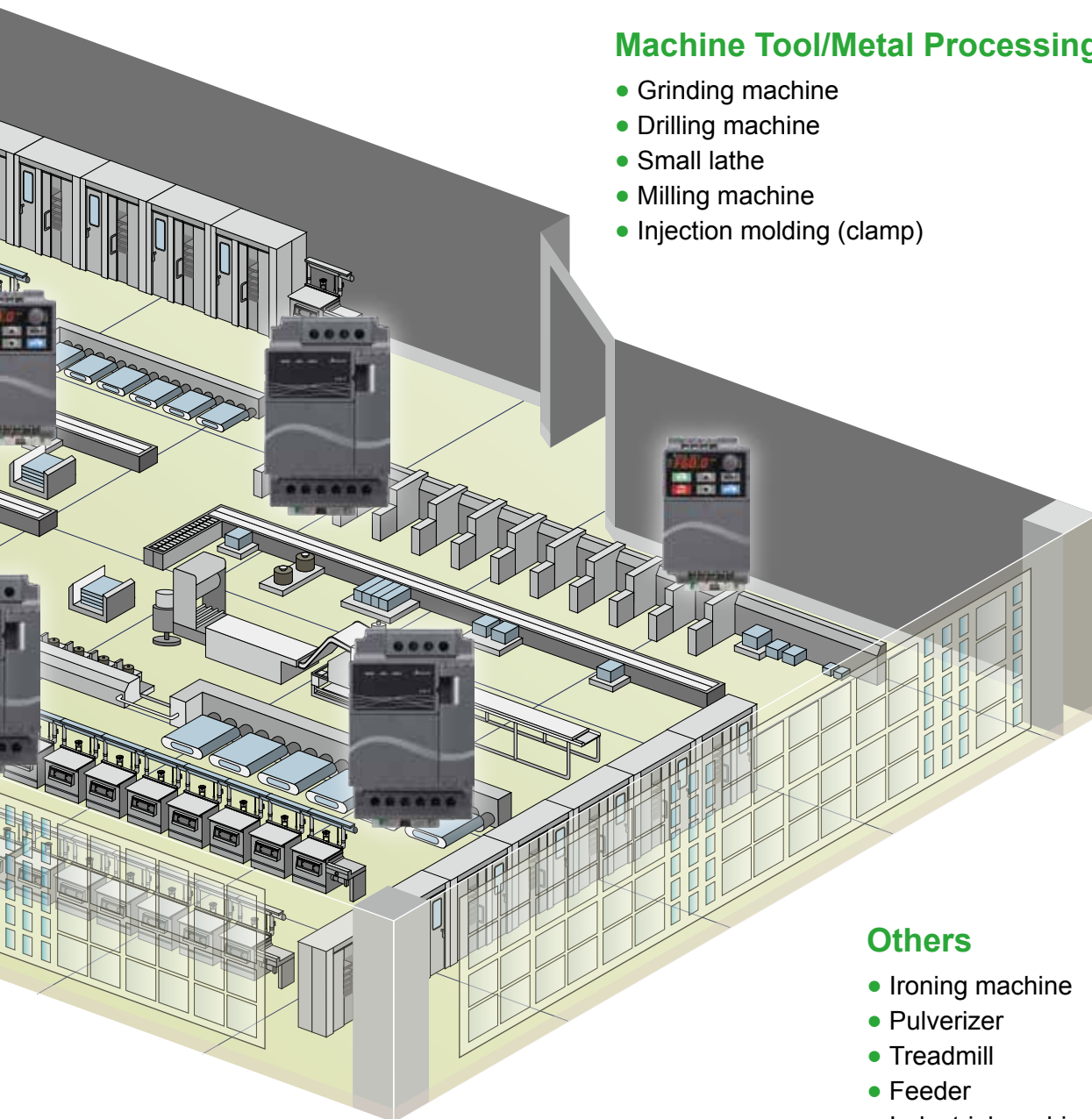

Others



- Ironing machine
- Pulverizer
- Treadmill
- Feeder
- Industrial washing machine
- Car washing machine
- Packing machine
- Centrifuge
- Liquid mixing machine

Specifications

115V	Voltage Class	115V		
	Model Number VFD-__ E	002	004	007
	Max. Applicable Motor Output (kW)	0.2	0.4	0.75
	Max. Applicable Motor Output (hp)	0.25	0.5	1.0
Output Rating	Rated Output Capacity (kVA)	0.6	1.0	1.6
	Rated Output Current (A)	1.6	2.5	4.2
	Maximum Output Voltage (V)	3-phase proportional to twice the input voltage		
	Output Frequency (Hz)	0.1~599Hz		
	Carrier Frequency (kHz)	1-15		
Input Rating	Rated Input Current (A)	Single-phase		
		6	9	18
	Rated Voltage/Frequency	Single-phase 100-120V, 50/60Hz		
	Voltage Tolerance	±10% (90-132V)		
	Frequency Tolerance	±5% (47-63Hz)		
	Cooling Method	Natural cooling		Fan cooling
	Weight (kg)	1.2	1.2	1.2

230V	Voltage Class	230V									
	Model Number VFD-__ E	002	004	007	015	022	037	055	075	110	150
	Max. Applicable Motor Output (kW)	0.2	0.4	0.75	1.5	2.2	3.7	5.5	7.5	11	15
	Max. Applicable Motor Output (hp)	0.25	0.5	1.0	2.0	3.0	5.0	7.5	10	15	20
Output Rating	Rated Output Capacity (kVA)	0.6	1.0	1.6	2.9	4.2	6.5	9.5	12.5	17.1	25
	Rated Output Current (A)	1.6	2.5	4.2	7.5	11	17	25	33	45	65
	Maximum Output Voltage (V)	3-phase proportional to twice the input voltage									
	Output Frequency (Hz)	0.1~599Hz									
	Carrier Frequency (kHz)	1-15									
Input Rating	Rated Input Current (A)	Single/3-phase					3-phase				
		4.9/1.9	6.5/2.7	9.7/5.1	15.7/9	24/15	20.6	26	34	48	70
	Rated Voltage/Frequency	Single/3-phase, 200-240V, 50/60Hz					3-phase, 200-240V, 50/60Hz				
	Voltage Tolerance	±10% (180-264V)									
	Frequency Tolerance	±5% (47-63Hz)									
	Cooling Method	Natural cooling				Fan cooling					
	Weight (kg)	1.1	1.1	1.1	1.9	1.9	1.9	3.5	3.5	3.57	6.6

460V	Voltage Class	460V											
	Model Number VFD-__ E	004	007	015	022	037	055	075	110	150	185	220	
	Max. Applicable Motor Output (kW)	0.4	0.75	1.5	2.2	3.7	5.5	7.5	11	15	18.5	22	
	Max. Applicable Motor Output (hp)	0.5	1.0	2.0	3.0	5.0	7.5	10	15	20	25	30	
Output Rating	Rated Output Capacity (kVA)	1.2	2.0	3.3	4.4	6.8	9.9	13.7	18.3	24	29	34	
	Rated Output Current (A)	1.5	2.5	4.2	5.5	8.5	13	18	24	32	38	45	
	Maximum Output Voltage (V)	3-phase proportional to input voltage											
	Output Frequency (Hz)	0.1~599Hz											
	Carrier Frequency (kHz)	1-15											
Input Rating	Rated Input Current (A)	3-phase											
		1.9	3.2	4.3	7.1	11.2	14	19	26	35	41	49	
	Rated Voltage/Frequency	3-phase, 380-480V, 50/60Hz											
	Voltage Tolerance	±10% (342-528V)											
	Frequency Tolerance	±5% (47-63Hz)											
	Cooling Method	Natural cooling			Fan cooling								
	Weight (kg)	1.2	1.2	1.2	1.9	1.9	4.2	4.2	4.2	7.47	7.47	7.47	

Control Characteristics	Control System		SPWM (Sinusoidal Pulse Width Modulation) Control (V/F or sensorless vector control)
	Frequency Setting Resolution		0.01 Hz
	Output Frequency Resolution		0.01 Hz
	Torque Characteristics		Including the auto-torque/auto-slip compensation; starting torque can be 150% at 3.0Hz
	Overload Endurance		150% of rated current for 1 minute
	Skip Frequency		Three zones, setting range 0.1~599 Hz
	Accel/Decel Time		0.1 to 600 seconds (2 Independent setting of Accel/Decel time)
	Stall Prevention Level		Setting 20 to 250% of rated current
	DC Braking		Operation frequency 0.1~599.0Hz, output 0~100% rated current Start time 0~60 seconds, stop time 0~60 seconds
	Regenerated Braking Torque		Approx. 20% (up to 125% possible with optional brake resistor or externally mounted brake unit, 1-15hp models (built-in brake chopper))
	V/F Pattern		Adjustable V/F pattern
	Operating Characteristics	Frequency Setting	Keypad
External Signal			Potentiometer 5kΩ/0.5W, 0 to +10V _{DC} , 4 to 20mA, RS-485 interface; Multi-function Inputs 3 to 9 (15 steps, Jog, up/down)
Operation Setting Signal		Keypad	Set by RUN and STOP
		External Signal	2 wires/3 wires (MI1, MI2, MI3), JOG operation, RS-485 serial interface (MODBUS), programmable logic controller
Multi-function Input Signal		Multi-step selection 0 to 15, Jog, accel/decel inhibit, 2 accel/decel switches, counter, external Base Block (NC, NO), auxiliary motor control is invalid, AC1/AV1/AUI selections, driver reset, UP/DOWN key settings, sink/source (=NPN/PNP) selection	
Multi-function Output Indication		AC drive operating, frequency attained, non-zero frequency, Base Block, fault indication, local/remote indication, auxiliary motor output, drive is ready, overheat alarm, emergency stop and status selections of input terminals (NC/NO)	
Analog Output Signal		Output frequency/current	
Alarm Output Contact		Contact will be On when drive malfunctions (1 Form C/change-over contact or 1 open collector output)	
Operation Functions		Built-in PLC, AVR, accel/decel S-Curve, over-voltage/over-current stall prevention, 5 fault records, reverse inhibition, momentary power loss restart, DC braking, auto torque/slip compensation, auto tuning, adjustable carrier frequency, output frequency limits, parameter lock/reset, vector control, PID control, external counter, MODBUS communication, abnormal reset, abnormal re-start, power-saving, sleep/wake function, fan control, 1st/2nd frequency source selections, 1st/2nd frequency source combination, NPN/PNP selection	
Protection Functions		Over voltage, over current, under voltage, under current, external fault, overload, ground fault, overheating, electronic thermal, IGBT short circuit, PTC, instantly stop and then reboot (up to 20 sec by setting parameter)	
Display Keypad		6-key, 7-segment LED with 4-digit, 5 status LED, master frequency, output frequency, output current, custom units, parameter values for setup and lock, faults, RUN, STOP, RESET, FWD/REV	
Built-in EMC Filter		For 230V 1-phase and 460V 3-phase models	
Environmental Conditions	Enclosure Rating		IP20
	Pollution Degree		2
	Installation Location		Altitude 1,000m or lower, keep from corrosive gasses, liquid and dust
	Ambient Temperature		-10°C to + 50°C (40°C for side-by-side mounting) Non-Condensing and not frozen
	Storage/Transportation Temperature		-20°C to 60°C
	Ambient Humidity		Below 90% RH (non-condensing)
Vibration		10 Hz ≤ f ≤ 57 Hz Fix Amplitude: 0.075 mm, 57 Hz ≤ f ≤ 150 Hz Fix Acceleration: 1 G (According to IEC 60068-2-6)	
Certifications		  	

Dimensions

Frame A1

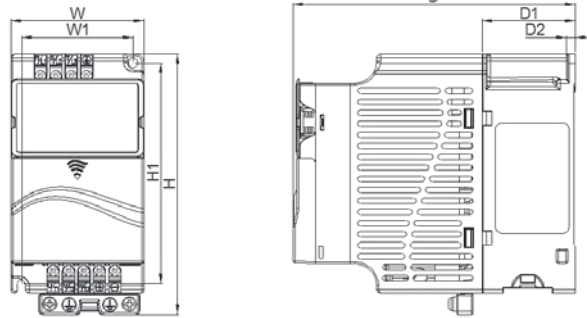

MODEL

- VFD002E11A/11C/11T
- VFD002E21A/21C/21T
- VFD002E23A/23C/23T
- VFD004E11A/11C/11T
- VFD004E21A/21C/21T
- VFD004E23A/23C/23T
- VFD004E43A/43C/43T
- VFD007E23A/23C/23T
- VFD007E43A/43C/43T

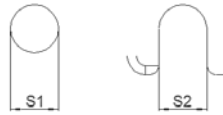
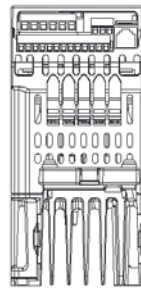

Unit: mm[inch]

Frame		W	W1	H	H1	D	D1	D2	S1	S2
A1	mm	72.0	60.0	142.0	120.0	152.0	50.0	4.5	5.2	5.2
	inch	2.83	2.36	5.59	4.72	5.98	1.97	0.18	0.20	0.20

Frame A2

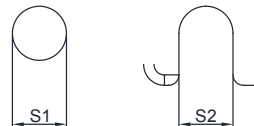
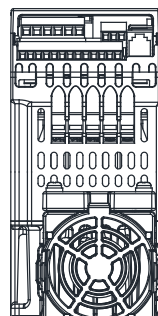
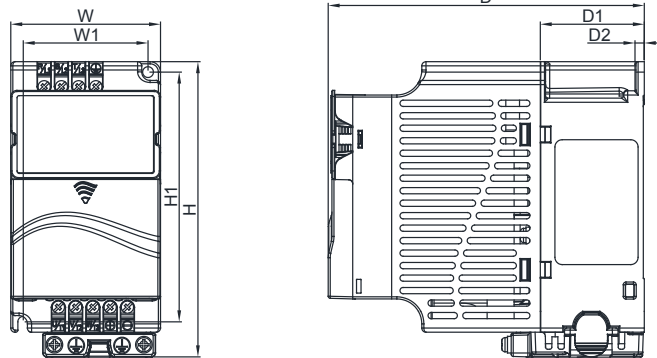

MODEL

- VFD015E23A/23C/23T
- VFD015E43A/43C/43T

Unit: mm[inch]

Frame		W	W1	H	H1	D	D1	D2	S1	S2
A2	mm	72.0	60.0	142.0	120.0	152.0	50.0	4.5	5.2	5.2
	inch	2.83	2.36	5.59	4.72	5.98	1.97	0.18	0.20	0.20

Frame A3

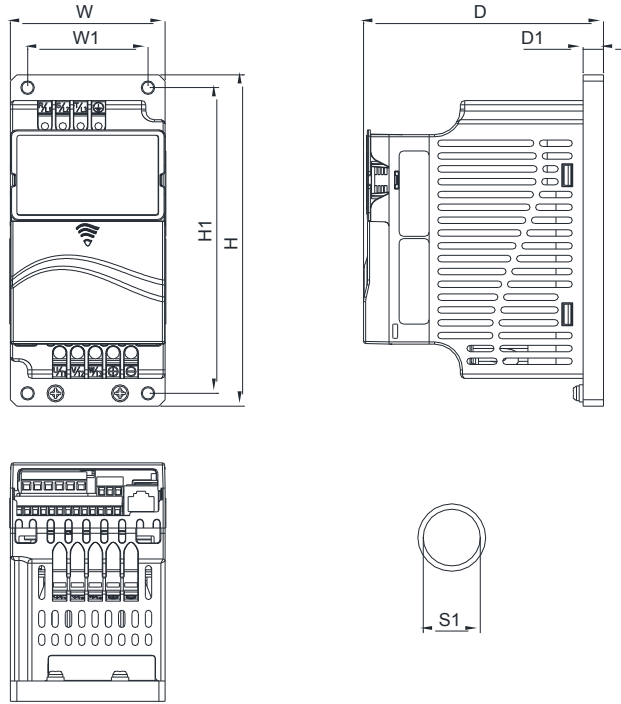

MODEL

- VFD002E11P/21P/23P
- VFD004E11P/21P/23P/43P
- VFD007E21P/23P/43P
- VFD015E23P/43P

Unit: mm[inch]

Frame		W	W1	H	H1	D	D1	S1
A3	mm	72.0	56.0	155.0	143.0	111.5	9.5	5.3
	inch	2.83	2.20	6.10	5.63	4.39	0.37	0.21

Frame B

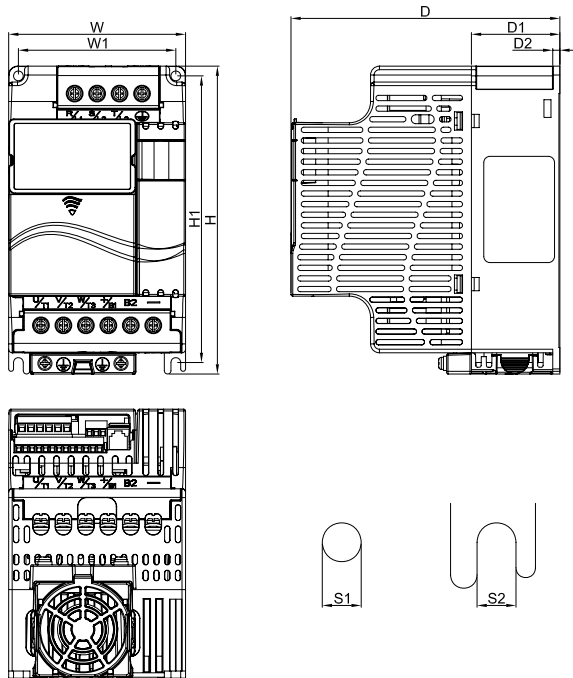

MODEL

- VFD007E11A/11C
- VFD015E21A/21C
- VFD022E21A/21C
- VFD022E23A/23C
- VFD022E43A/43C
- VFD037E23A/23C
- VFD037E43A/43C

Unit: mm[inch]

Frame		W	H	D	W1	H1	D1	D2	S1	S2
B	mm	100.0	174.0	152.0	89.0	162.0	50.0	4.0	5.5	5.5
	inch	3.94	6.86	5.98	3.50	6.86	1.97	0.16	0.22	0.22

Frame C

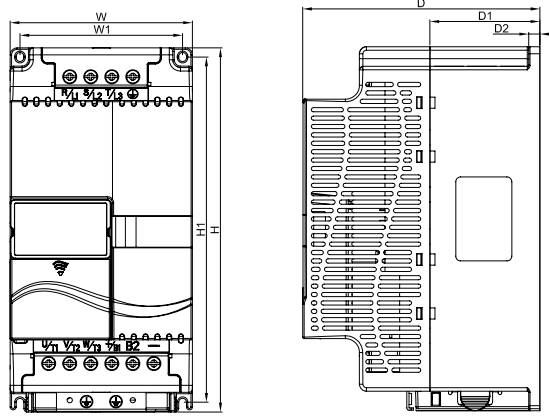

MODEL

VFD055E23A/23C
 VFD055E43A/43C
 VDF075E23A/23C
 VDF075E43A/43C
 VFD110E23A/23C
 VFD110E43A/43C

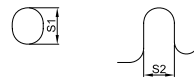
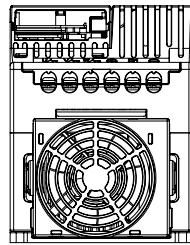

Unit: mm[inch]

Frame		W	H	D	W1	H1	D1	D2	S1	S2
C	mm	130.0	260.0	169.2	116.0	246.5	78.5	8.0	6.5	5.5
	inch	5.12	10.24	6.66	4.57	9.70	3.09	0.31	0.26	0.22

Frame D

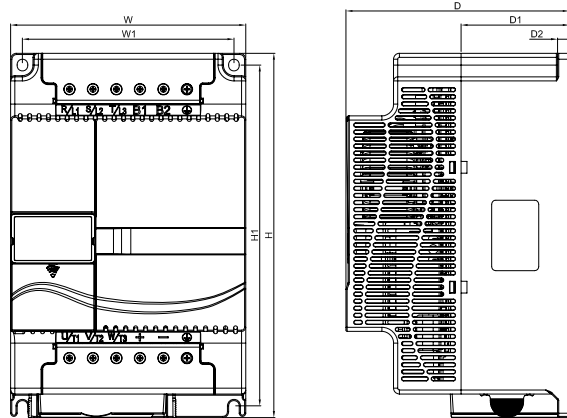

MODEL

VFD150E23A/23C
 VFD150E43A/43C
 VFD185E43A/43C
 VFD220E43A/43C

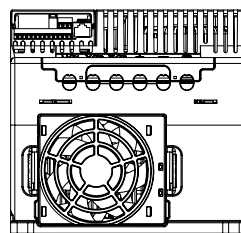

Unit: mm[inch]

Frame		W	H	D	W1	H1	D1	D2	S1	S2
D	mm	200.0	310.0	190.0	180.0	290.0	92.0	10.0	10.0	9.0
	inch	7.87	12.20	7.48	7.09	11.42	3.62	0.39	0.39	0.35

Accessories

Option Cards



- **EME-R3AA**
Relay card
(3 form A/ NO contacts)



- **EME-R2CA**
Relay card
(2 form C/Change-over contacts)



- **EME-A1D3A**
Anglog I/O Card (12 bits)



- **EME-A22A**
Anglog I/O Card (12 bits)



- **EME-PG01**
PG card



- **CME-USB01**
Second communication card
(USB1.1)



- **EME-D33A**
I/O card
(photocoupler 3in + 3out)

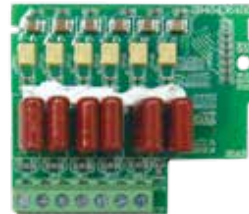

- **EME-D611A**
Multi-function Input
Terminal MI1~MI6-COM Card
(For Internal Installation)

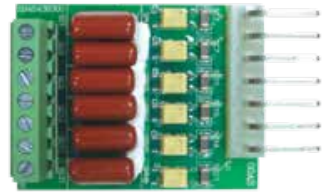

- **EME-D611B**
Multi-function Input Terminal
MI1~MI6-COM Card
(For External Installation)

Accessories

Fieldbus Modules



▪ **DeviceNet**
CME-DN01



▪ **PROFIBUS**
CME-PD01



▪ **CANopen**
CME-COP01

Others



▪ **Brake Unit**
BUE-20015 BUE-40015
BUE-20037 BUE-40037



▪ **Keypad for Communication**
VFD-PU06 / KPC-CC01



▪ **DIN Rail (Width 35mm)**
MKE-DRA MKE-DRB



▪ **Brake Resistor**



▪ **Zero Phase Reactor**
RF220X00A



▪ **Grounding Plate**
MKE-EP



▪ **Digital Keypad**

Ordering Information

VFD-E Series

Frame Size		Power Range	Models
Frame A1~A3		115V: 0.2kW ~ 0.4kW 230V: 0.2kW ~ 1.5kW 460V: 0.4kW ~ 1.5kW	Frame A1: VFD002E11A/11C/11T VFD002E21A/21C/21T VFD002E23A/23C/23T VFD004E11A/11C/11T VFD004E21A/21C/21T VFD004E23A/23C/23T VFD007E23A/23C/23T VFD007E43A/43C/43T Frame A2: VFD015E23A/23C/23T VFD015E43A/43C/43T Frame A3: VFD002E11P/21P/23P VFD004E11P/21P/23P/43P VFD007E21P/23P/43P VFD015E23P/43P
Frame B		115V: 0.75kW 230V: 1.5kW ~ 3.7kW 460V: 2.2kW ~ 3.7kW	VFD007E11A/11C VFD015E21A/21C VFD022E21A/21C VFD022E23A/23C VFD022E43A/43C VFD037E23A/23C VFD037E43A/43C
Frame C		230V: 5.5kW ~ 11kW 460V: 5.5kW ~ 11kW	VFD055E23A/23C VFD055E43A/43C VDF075E23A/23C VDF075E43A/43C VFD110E23A/23C VFD110E43A/43C
Frame D		230V: 15kW 460V: 15kW ~ 22kW	VFD150E23A/23C VFD150E43A/43C VFD185E43A/43C VFD220E43A/43C



Smarter. Greener. Together.

Industrial Automation Headquarters

Delta Electronics, Inc.

Taoyuan Technology Center
No.18, Xinglong Rd., Taoyuan District,
Taoyuan City 33068, Taiwan
TEL: 886-3-362-6301 / FAX: 886-3-371-6301

Asia

Delta Electronics (Shanghai) Co., Ltd.

No.182 Minyu Rd., Pudong Shanghai, P.R.C.
Post code : 201209
TEL: 86-21-6872-3988 / FAX: 86-21-6872-3996
Customer Service: 400-820-9595

Delta Electronics (Japan), Inc.

Tokyo Office
Industrial Automation Sales Department
2-1-14 Shibadaimon, Minato-ku
Tokyo, Japan 105-0012
TEL: 81-3-5733-1155 / FAX: 81-3-5733-1255

Delta Electronics (Korea), Inc.

Seoul Office
1511, 219, Gasan Digital 1-Ro., Geumcheon-gu,
Seoul, 08501 South Korea
TEL: 82-2-515-5305 / FAX: 82-2-515-5302

Delta Energy Systems (Singapore) Pte Ltd.

4 Kaki Bukit Avenue 1, #05-04, Singapore 417939
TEL: 65-6747-5155 / FAX: 65-6744-9228

Delta Electronics (India) Pvt. Ltd.

Plot No.43, Sector 35, HSIIDC Gurgaon,
PIN 122001, Haryana, India
TEL: 91-124-4874900 / FAX : 91-124-4874945

Delta Electronics (Thailand) PCL.

909 Soi 9, Moo 4, Bangpoo Industrial Estate (E.P.Z),
Pattana 1 Rd., T.Phraksa, A.Muang,
Samutprakarn 10280, Thailand
TEL: 66-2709-2800 / FAX : 662-709-2827

Delta Energy Systems (Australia) Pty Ltd.

Unit 20-21/45 Normanby Rd., Nottling Hill Vic 3168, Australia
TEL: 61-3-9543-3720

Americas

Delta Electronics (Americas) Ltd.

Raleigh Office
P.O. Box 12173, 5101 Davis Drive,
Research Triangle Park, NC 27709, U.S.A.
TEL: 1-919-767-3813 / FAX: 1-919-767-3969

Delta Greentech (Brasil) S/A

São Paulo Office
Rua Itapeva, 26 – 3° Andar - Bela Vista
CEP: 01332-000 – São Paulo – SP - Brasil
TEL: 55-11-3530-8642 / 55-11-3530-8640

Delta Electronics International Mexico S.A. de C.V.

Mexico Office
Vía Dr. Gustavo Baz No. 2160, Colonia La Loma,
54060 Tlalnepantla Estado de Mexico
TEL: 52-55-2628-3015 #3050/3052

EMEA

Delta Electronics (Netherlands) BV

Eindhoven Office
De Witbogt 20, 5652 AG Eindhoven, The Netherlands
MAIL: Sales.IA.EMEA@deltaww.com
MAIL: Sales.IA.Benelux@deltaww.com

Delta Electronics (France) S.A.

ZI du bois Chaland 2 15 rue des Pyrénées,
Lisses 91056 Evry Cedex, France
MAIL: Sales.IA.FR@deltaww.com

Delta Electronics Solutions (Spain) S.L.U

Ctra. De Villaverde a Vallecas, 265 1° Dcha Ed.
Hormigueras – P.I. de Vallecas 28031 Madrid
C/Llull, 321-329 (Edificio CINC) | 22@Barcelona, 08019 Barcelona
MAIL: Sales.IA.Iberia@deltaww.com

Delta Electronics (Italy) Srl

Ufficio di Milano Via Senigallia 18/2 20161 Milano (MI)
Piazza Grazioli 18 00186 Roma, Italy
MAIL: Sales.IA.Italy@deltaww.com

Delta Electronics (Germany) GmbH

Coesterweg 45, D-59494 Soest, Germany
MAIL: Sales.IA.DACH@deltaww.com

Delta Energy Systems LLC (CIS)

Vereyskaya Plaza II, office 112 Vereyskaya str.
17 121357 Moscow, Russia
MAIL: Sales.IA.RU@deltaww.com

Delta Greentech Ltd. (Turkiye)

Serifali Mevkii Barbaros Bulvari Soylesi Sok
No 19 34775, Y.Dudullu-Umraniye/Istanbul
MAIL: Sales.IA.Turkey@delta-emea.com

Delta Energy Systems AG (Dubai BR)

P.O. Box 185668, Gate 7, 3rd Floor, Hamarain Centre,
Dubai, United Arab Emirates
MAIL: Sales.IA.MEA@deltaww.com