

# Miniature Intermediate Power Relay HYE

- 10A Switching Capability
- 2kV dielectric strength (between coil and contacts)
- Plug-in or PCB mountable
- Different Sockets Available
- RoHS Compliant
- 2 to 4 pole configurations
- Outline Dimensions: 28.0 x 21.3 x 35.2mm



## Options & Ordering Codes

<b>HYE</b>	<b>4</b>	<b>1</b>	<b>PN</b>	<b>24VDC</b>
<b>Contact Arrangement</b>				<b>Coil Voltage</b>
2 Pole CO	<b>2</b>			
3 Pole CO	<b>3</b>			
4 Pole CO	<b>4</b>			
<b>Termination</b>			<b>PN</b>	Mechanical indicator /test latch LED
Plug-In		<b>1</b>	<b>XX</b>	No indication
PCB		<b>2</b>		



Contact Data		
<b>Contact Arrangement</b>	2P / 3P	4P
<b>Contact Resistance</b>	50mΩ (at 1A 24VDC)	
<b>Contact Material</b>	AgSnO <sub>2</sub>	
<b>Contact Rating</b>	10A 250VAC/30 VDC	5A 250VAC/30 VDC
<b>Max. Switching Voltage</b>	250VAC / 30VDC	
<b>Max. Switching Current</b>	10A	5A
<b>Max. Switching Power</b>	2500VA / 300W	1250 VA / 150 W
<b>Mechanical Life</b>	1x10 <sup>7</sup> OPS	
<b>Electrical Life</b>	1x10 <sup>5</sup> OPS	

Characteristics		
<b>Initial Insulation Resistance</b>		1000MΩ (at 500VDC)
<b>Dielectric Strength</b>	Between coil & contacts	1500VAC 1min
	Between open contacts	1000VAC 1min
	Between contact sets	1500VAC 1min
<b>Operate Time (at nominal voltage)</b>		25ms max.
<b>Release Time (at nominal voltage)</b>		25ms max.
<b>Shock Resistance</b>	Functional	100m/s <sup>2</sup>
	Destructive	1000m/s <sup>2</sup>
<b>Vibration Resistance</b>		10 to 55Hz 1.5mm DA
<b>Ambient Temperature</b>		-40°C to +70°C
<b>Humidity</b>		98% RH, +40°C
<b>Termination</b>	8 Pin	PCB, Plug-In
<b>Unit Weight</b>		Approx 37g
<b>Construction</b>		Dust Protected

Coil		
<b>Coil Power</b>	DC Type	900mW
	AC Type	1.2VA

Coil Data <span style="float: right;">at 23°C</span>			
Nominal Voltage VDC	Pick-Up Voltage VDC	Drop-Out Voltage VDC	Coil Resistance Ω
6	4.8	0.6	40 (1±10%)
12	9.6	1.2	160 (1±10%)
24	19.2	2.4	650 (1±10%)
48	38.4	4.8	2600 (1±10%)
110	88.0	11.0	11000 (1±10%)

Nominal Voltage VAC	Pick-Up Voltage VAC	Drop-Out Voltage VAC	Coil Resistance Ω
6	4.8	1.8	12 (1±10%)
12	9.6	3.6	46 (1±10%)
24	19.2	7.2	180 (1±10%)
48	38.4	14.4	780 (1±10%)
110	80.0	30.0	3750 (1±10%)
220	160.0	60.0	12950 (1±10%)
230	176.0	66.0	18790 (1±10%)

# Miniature Intermediate Power Relay HYE

## 2 and 3 POLES

### Plug-in

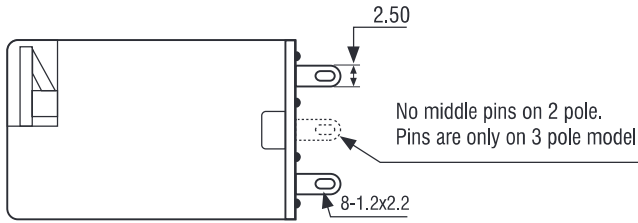

### PCB

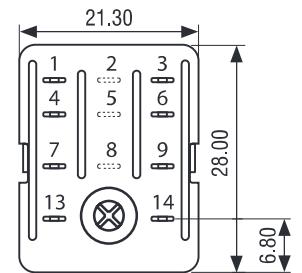
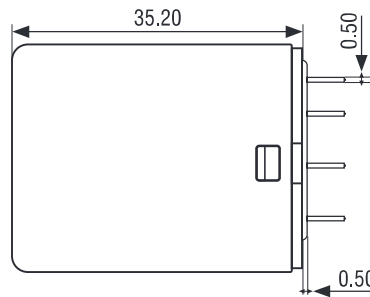
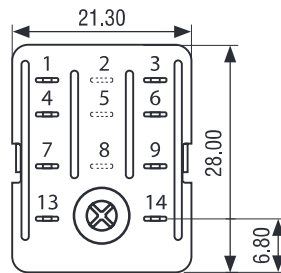
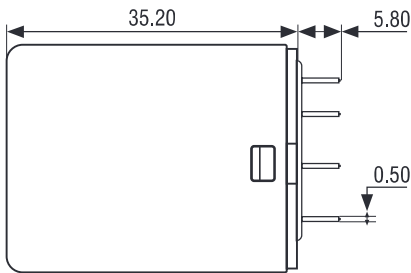
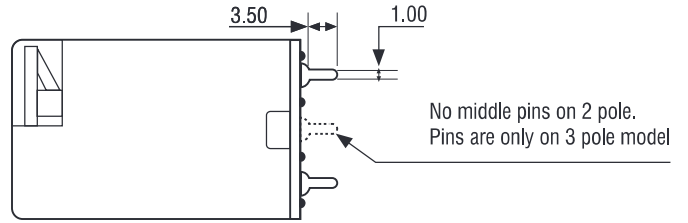

## 4 POLES

### Plug-in

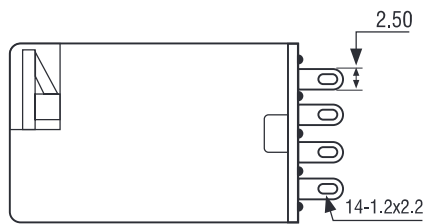

### PCB

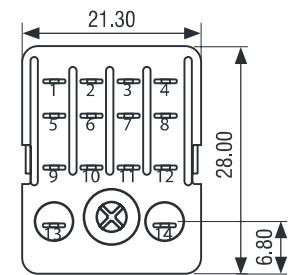
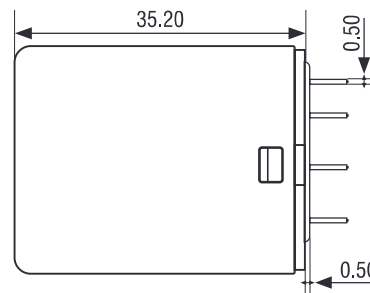
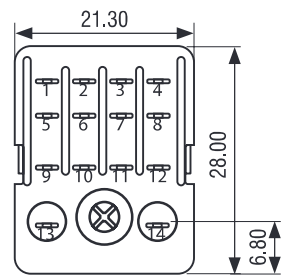
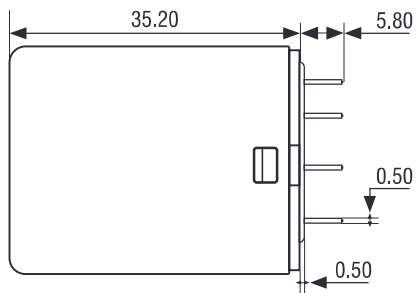
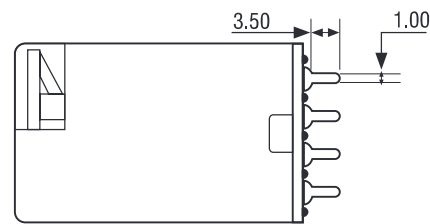

## PCB LAYOUT

### 2 Poles CO

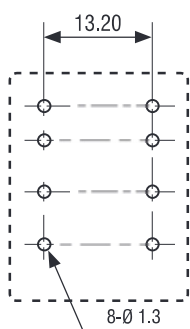

### 3 Poles CO

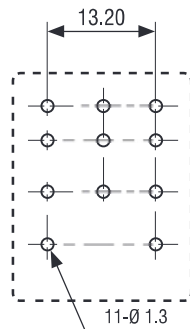

### 4 Poles CO

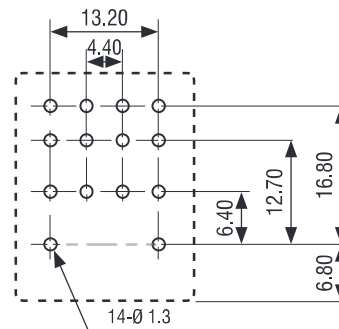

# Miniature Intermediate Power Relay HYE

## WIRING DIAGRAM

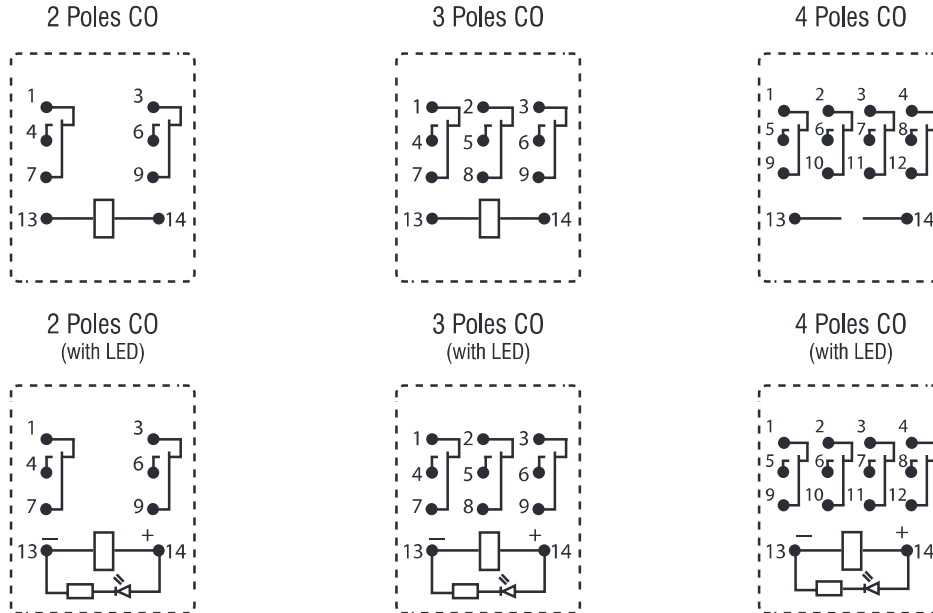

## Bases - Dimensions (mm)



Relay	Base	Nominal Voltage (V)	Nominal Current (A)	Ambient Temperature	Dielectric Strength Min.	Screw Torque (Nm)	Wire Strip Length (mm)
2P	SRNE2-D	300V	10A	-25 to 85°C	2500VAC	0.6	7mm
2P	SRNE2-S	300V	10A	-25 to 85°C	2500VAC	0.6	7mm
3P	SRNE3-C	300V	10A	-25 to 85°C	2500VAC	0.6	7mm
3P	SRNE3-D	300V	10A	-25 to 85°C	2500VAC	0.6	7mm
4P	SRPE4-0	300V	10A	-25 to 85°C	2500VAC	N/A	N/A
4P	SRNE4-C	300V	10A	-25 to 85°C	2500VAC	0.6	7mm
4P	SRNE4-D	300V	10A	-25 to 85°C	2500VAC	0.6	7mm
4P	SRNE4-S	300V	10A	-25 to 85°C	2500VAC	0.6	7mm

## SRNE2-D

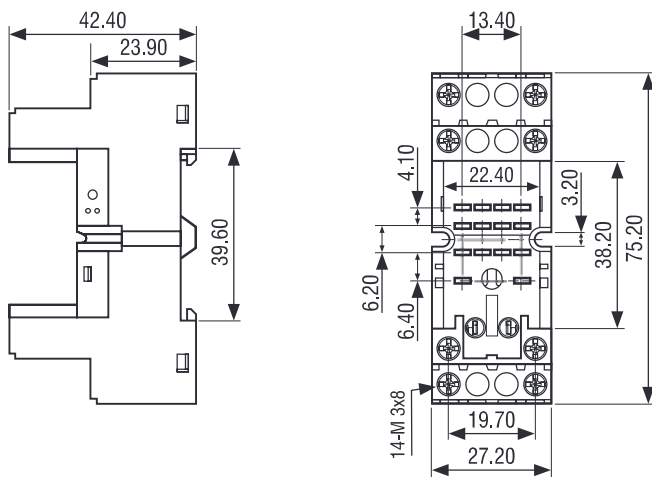

## Wiring Diagram

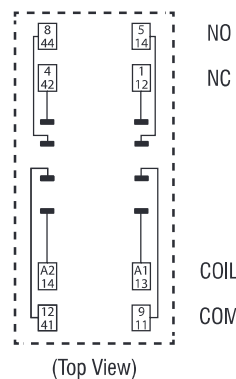

**ACCESSORY**  
Metallic retainer RC4-N  
Marker - SRN-BM-1  
Plug-in modules PDME1 to RPDME1

# Miniature Intermediate Power Relay HYE

## SRNE2-S

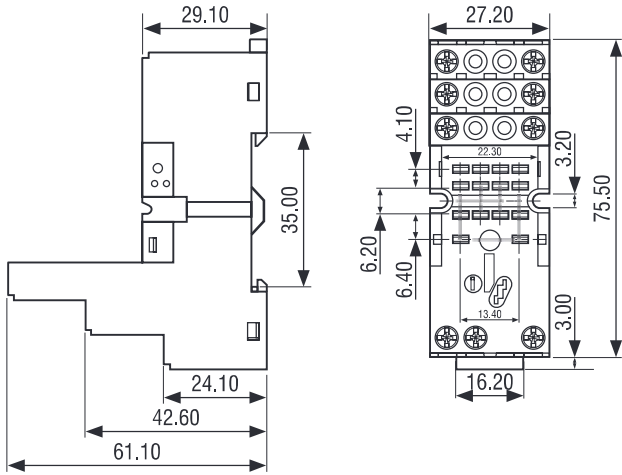

### Wiring Diagram

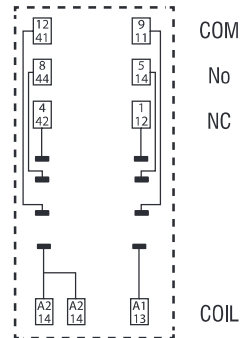

(Top View)



### ACCESSORY

Metallic retainer RC4-N  
Marker - SRN-BM-1  
Plug-in modules PDME1 to RPDME1

## SRNE3-C

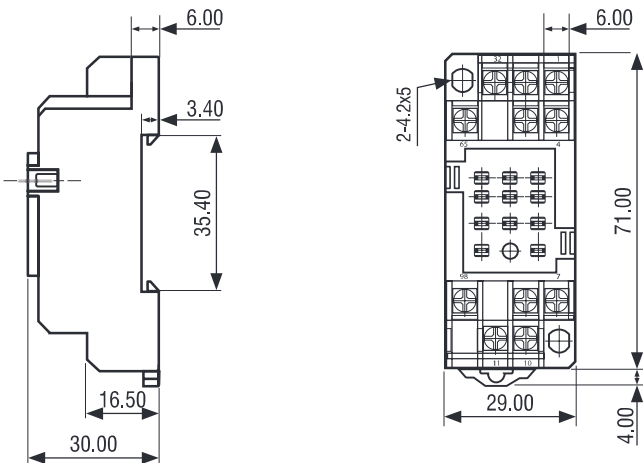

### Wiring Diagram

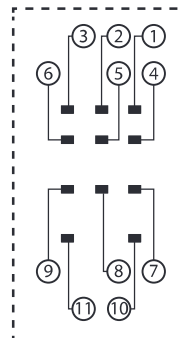

(Top View)

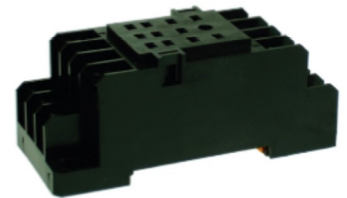

## SRNE3-D

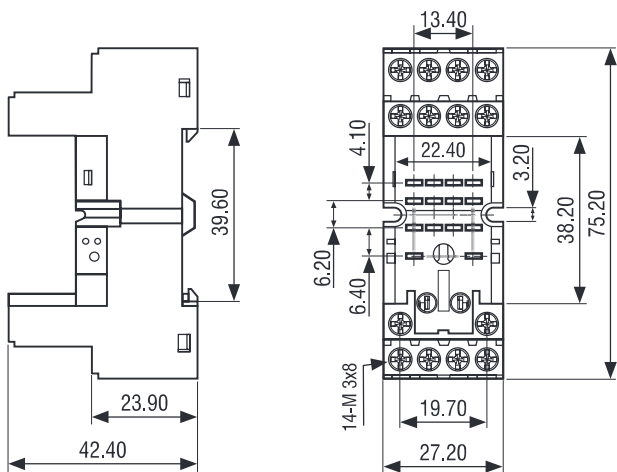

### Wiring Diagram

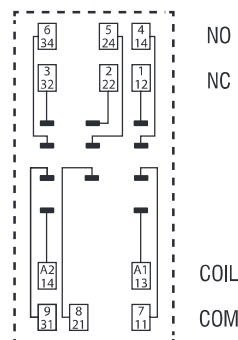

(Top View)



### ACCESSORY

Metallic retainer RC4-N  
Marker - SRN-BM-1  
Plug-in modules PDME1 to RPDME1

# Miniature Intermediate Power Relay HYE

## SRPE4-0

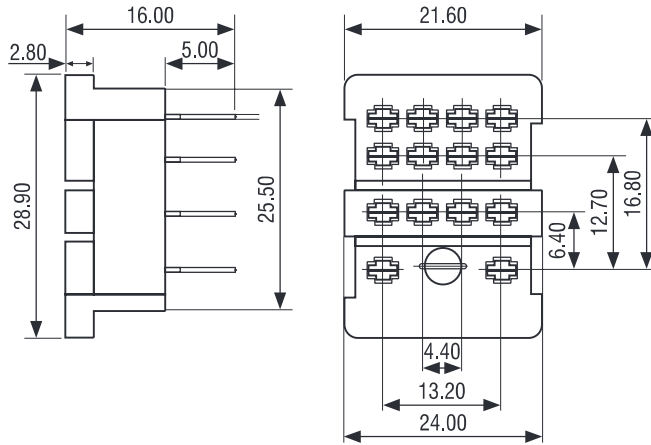

## PCB Layout

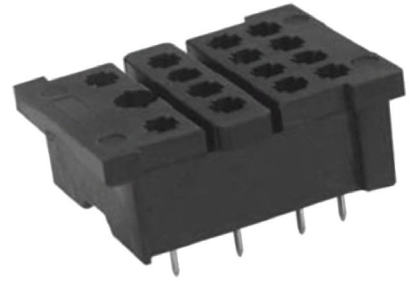
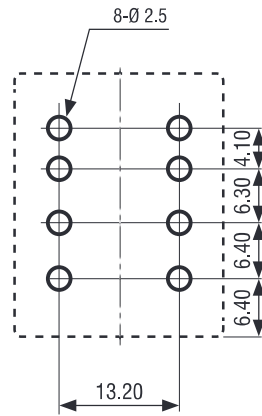

**ACCESSORY**  
Metallic retainer SRC-CLIP

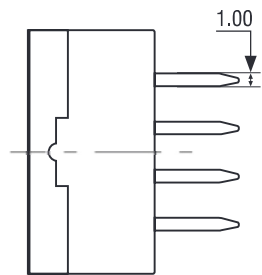

## SRNE4-C

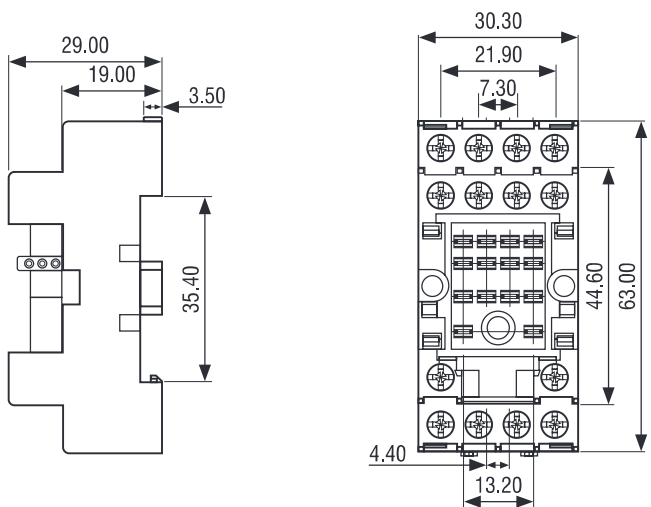

## Wiring Diagram

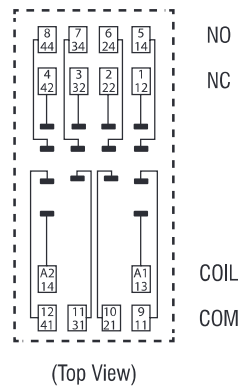

**ACCESSORY**  
Metallic retainer RC4-N

# Miniature Intermediate Power Relay HYE

## SRNE4-D

### Wiring Diagram

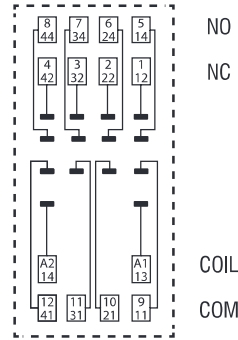
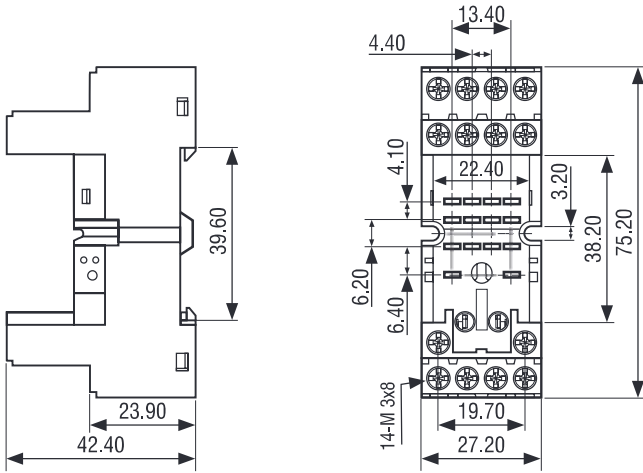

(Top View)



**ACCESSORY**  
Metallic retainer RC4-N  
Marker - SRN-BM-1  
Plug-in modules PDME1 to RPDME1

## SRNE4-S

### Wiring Diagram

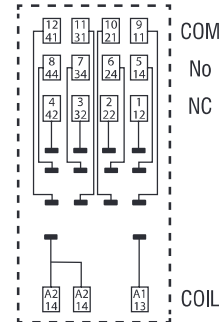
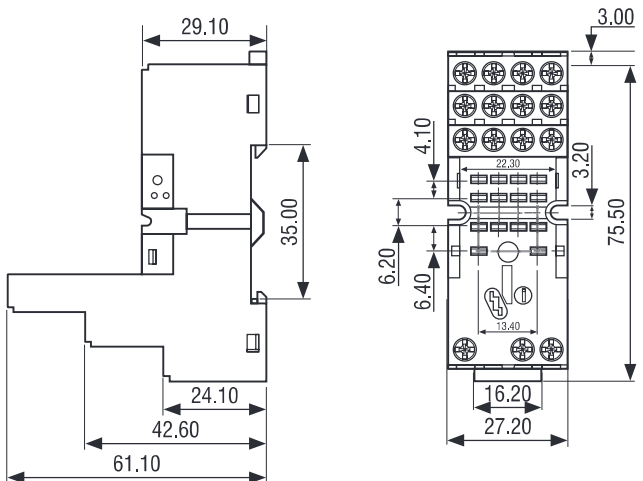

(Top View)



**ACCESSORY**  
Metallic retainer RC4-N  
Marker - SRN-BM-1  
Plug-in modules PDME1 to RPDME1

# Miniature Intermediate Power Relay HYE

## DIMENSIONS OF RELATED COMPONENT

### Retainers

#### SRC-CLIP

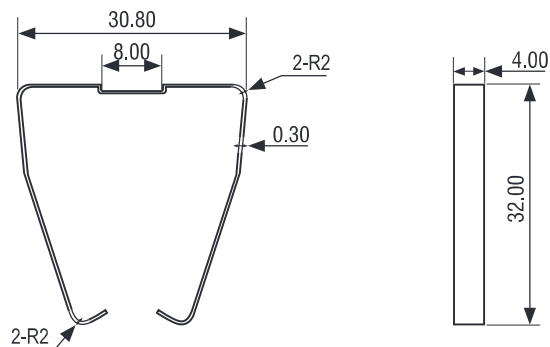

#### RC4-N

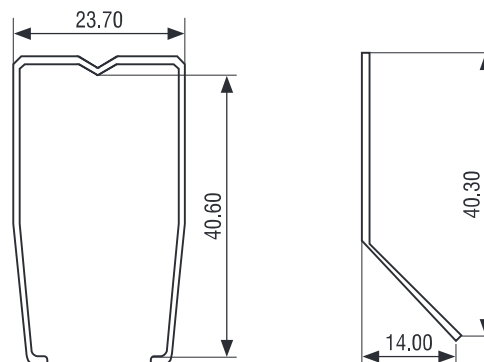

### Markers

#### SRN-BM-1

