

SPZ, SPA, SPB és SPC ÖNTÖTTVAS TRAPÉZ HORNÝÚ ÉKSZÍJTÁRCSÁK TAPER-LOCK® KÚPOS RÖGZÍTÉSSEL

A trapéz hornyú ékszíjtárcsák kialakítása: szabványos.
Anyaga: GG 20 öntöttvas foszfátózott felületvédelemmel.

Standard normális kialakítás, a tárcsák statikusan kiegyensúlyozottak, megengedhető kerületi sebesség akár 25 m / sec.

Nagyobb sebesség esetén dinamikus kiegyensúlyozás szükséges!

CHIARAVALLI Transmissionsi SpA külön kérésre képes max. 630 mm átmérőig a tárcsák dinamikus kiegyensúlyozását elvégezni. Ekkor a kiegyensúlyozás tanúsítványát csatolják.

35 m / sec-nél nagyobb kerületi sebességre az öntöttvas tárcsák már nem alkalmasak, ez a sebességtartomány nagyobb szilárdságú anyagok alkalmazását követeli meg.

$$V_p = \frac{\pi \cdot D \cdot n}{60} = \frac{D \cdot n}{19,1} \text{ m/sec.}$$

$$V_p = \text{kerületi sebesség (m/s)} \quad \pi = 3,14$$

$$D = \text{Átmérő (m)}$$

$$n = \text{Fordulatszám (1/s)}$$

A táblázatban megadott méretek nem kötelezőek, de tiszteletben kell tartani.

Módosítás és változtatás jogát fenntartjuk.

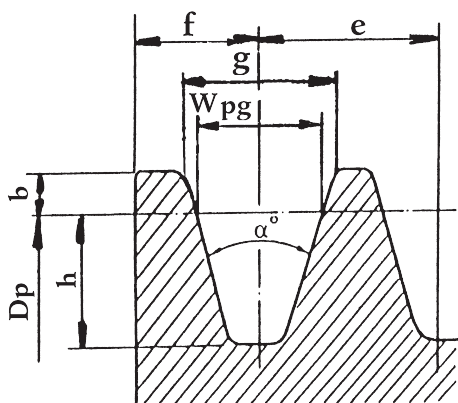

Profil	D _p mm	α°	W _{pg}	g	h	b _{min}	f	e
SPZ	< 80	34°	8,5	9,7	9	2	8	12
	> 80	38°						
SPA	< 118	34°	11	12,7	11	2,8	10	15
	> 118	38°						
SPB	< 190	34°	14	16,3	14	3,5	12,5	19
	> 190	38°						
SPC	< 315	34°	19	22,0	19	4,8	17	25,5
	> 315	38°						

Horony szám N	SPZ	SPA	SPN	SPC
1	16	20	25	34
2	28	35	44	59,5
3	40	50	63	85
4	52	65	82	111
5	64	80	101	136
6		95	120	162
8			158	213
10			196	264



TAPER-LOCK® KÚPOS RÖGZÍTÉSŰ ÉKSZÍJTÁRCSÁK MÉRETEI

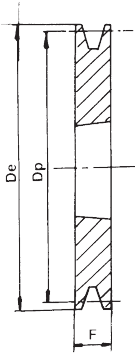

1 kivitel

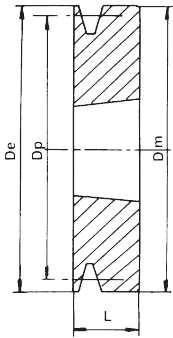

2 kivitel

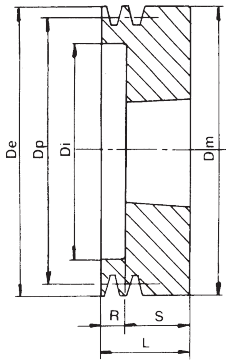

3 kivitel

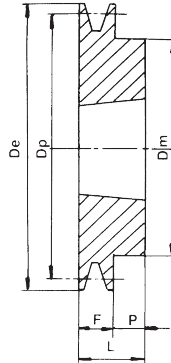

4 kivitel

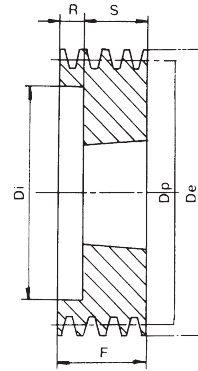

5 kivitel

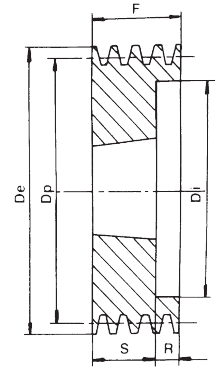

6 kivitel

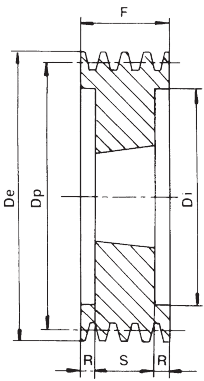

7 kivitel

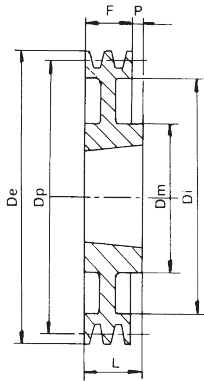

8 kivitel

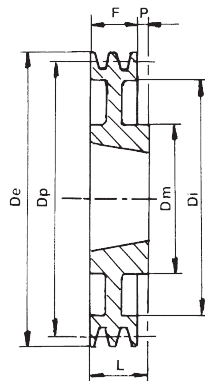

8A kivitel

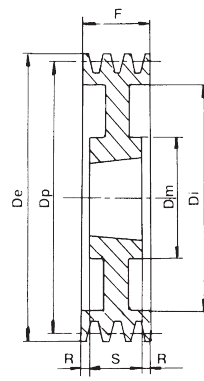

9 kivitel

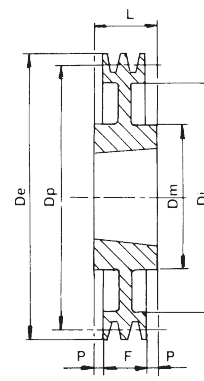

10 kivitel

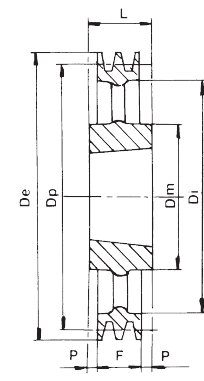

11 kivitel

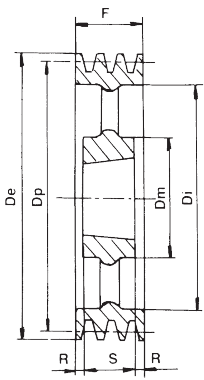

12 kivitel

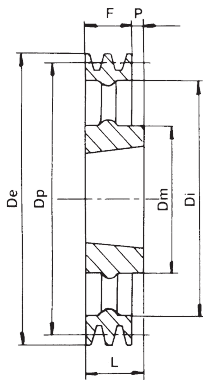

13 kivitel

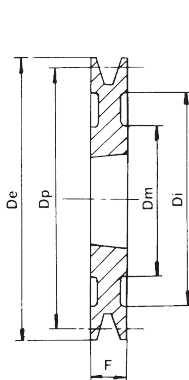

14 kivitel

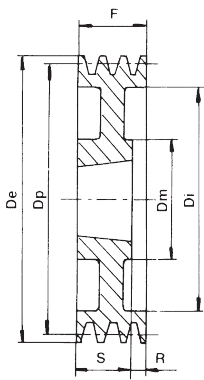

15 kivitel

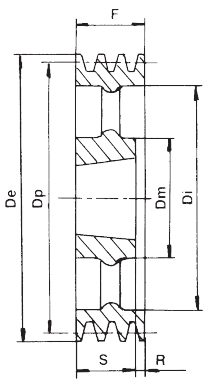

16 kivitel

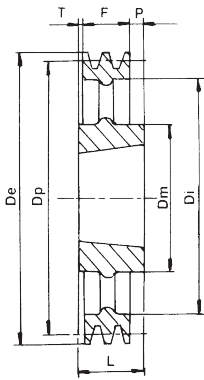

17 kivitel



ETSPZ
ETSPZ0601

SPZ ÉKSZÍJTÁRCSÁK TAPER-LOCK® KÚPOS RÖGZÍTÉSSEL

SPZ ékszíjtárcsák				Anyag: Öntöttvas							
Dp osztókör	Horony N	Taper- Lock® Kivitel	De külső	Di	Dm agy	F	L	P	R	S	
60	1	2	1008	64,6		64,6		22			
	2	3	1108	"	36	64,6		49		27	
63	1	4	1108	67,6		62	16	22	6		
	2	5	1108	"	40		28			6	
	3	5	1108	"	40		40			18	
67	1	4	1108	71,6		62	16	22	6		
	2	5	1108	"	42		28			6	
	3	5	1108	"	42		40			18	
71	1	4	1108	75,6		62	16	22	6		
	2	5	1108	"	42		28			6	
	3	5	1108	"	42		40			18	
75	1	4	1108	79,6		62	16	22	6		
	2	5	1210	"	51		28			3	
	3	5	1210	"	48		40			15	
80	1	4	1210	84,6		75	16	25	9		
	2	5	1210	"	51		28			3	
	3	5	1210	"	51		40			15	
	4	5	1210	"	51		52			27	
85	1	4	1210	89,6		75	16	25	9		
	2	5	1610	"	60		28			3	
	3	5	1610	"	60		40			15	
	4	5	1610	"	60		52			27	
	5	5	1610	"	60		64			39	
90	1	4	1210	94,6		75	16	25	9		
	2	5	1610	"	61		28			3	
	3	5	1610	"	61		40			15	
	4	5	1610	"	61		52			27	
	5	5	1610	"	61		64			39	
95	1	4	1210	99,6		75	16	25	9		
	2	5	1610	"	66		28			3	
	3	5	1610	"	66		40			15	
	4	5	1610	"	66		52			27	
	5	5	1610	"	66		64			39	
100	1	4	1210	104,6		75	16	25	9		
	2	5	1610	"	71		28			3	
	3	5	1610	"	71		40			15	
	4	5	1610	"	72		52			27	
	5	5	2012	"	72		64			32	
106	1	4	1610	110,6		80	16	25	9		
	2	5	1610	"	76		28			3	
	3	5	1610	"	78		40			15	
	4	5	1610	"	80		52			27	
	5	5	2012	"	78		64			32	

ETSPZ
ETSPZ1121**SPZ ÉKSZÍJTÁRCSÁK**
TAPER-LOCK® KÚPOS RÖGZÍTÉSSEL

SPZ ékszíjtárcsák

Anyag: Öntöttvas

Dp osztókör	Horony N	Taper- Lock® Kivitel	De külső	Di	Dm agy	F	L	P	R	S
112	1	4	1610	116,6		80	16	25	9	
	2	5	1610	"	84		28			3
	3	5	2012	"	84		40			8
	4	5	2012	"	86		52			20
	5	5	2012	"	84		64			32
118	1	4	1610	122,6		80	16	25	9	
	2	5	1610	"	90		28			3
	3	5	2012	"	92		40			8
	4	5	2012	"	92		52			20
	5	5	2012	"	90		64			32
125	1	4	1610	129,6		80	16	25	9	
	2	5	1610	"	97		28			3
	3	6	2012	"	97		40			8
	4	6	2012	"	99		52			20
	5	5	2012	"	97		64			32
132	1	4	1610	136,6		80	16	25	9	
	2	5	1610	"	104		28			3
	3	6	2012	"	104		40			8
	4	6	2012	"	104		52			20
	5	5	2517	"	104		64			19
140	1	4	1610	144,6		80	16	25	9	
	2	5	1610	"	112		28			3
	3	6	2012	"	112		40			8
	4	6	2012	"	112		52			20
	5	6	2517	"	112		64			19
150	1	4	1610	154,6		80	16	25	9	
	2	4	2012	"		100	28	32	4	
	3	6	2012	"	122		40			8
	4	6	2517	"	122		52			7
	5	6	2517	"	122		64			19
160	1	4	1610	164,6		80	16	25	9	
	2	4	2012	"		100	28	32	4	
	3	6	2012	"	132		40			8
	4	6	2517	"	132		52			7
	5	6	2517	"	132		64			19
180	1	4	1610	184,6		80	16	25	9	
	2	8	2012	"	152		28	32	4	
	3	6	2012	"	152		40			8
	4	6	2517	"	152		52			7
	5	6	2517	"	152		64			19

ETSPZ
ETSPZ2001**SPZ ÉKSZÍJTÁRCSÁK**
TAPER-LOCK® KÚPOS RÖGZÍTÉSSEL

SPZ ékszíjtárcsák

Anyag: Öntöttvas

Dp osztókör	Horony N	Taper- Kivitel Lock®	De külső	Di	Dm agy	F	L	P	R	S
200	1	8	2012	204,6	172	100	16	32	16	
	2	8	2012	"	171	100	28	32	4	
	3	9	2012	"	172	100	40		4	32
	4	9	2517	"	172	120	52		3,5	45
	5	9	2517	"	172	120	64		9,5	45
224	1	8	2012	228,6	196	100	16	32	16	
	2	8	2012	"	196	100	28	32	4	
	3	9	2012	"	196	100	40		4	32
	4	9	2517	"	196	120	52		3,5	45
	5	9	2517	"	196	120	64		9,5	45
250	1	11	2012	254,6	222	100	16	32	8	
	2	11	2012	"	222	100	28	32	2	
	3	12	2012	"	222	100	40		4	32
	4	12	2517	"	222	120	52		3,5	45
	5	12	2517	"	222	120	64		9,5	45
280	1	11	2012	284,6	252	100	16	32	8	
	2	11	2012	"	252	100	28	32	2	
	3	11	2517	"	252	120	40	45	2,5	
	4	12	2517	"	252	120	52		3,5	45
	5	12	2517	"	252	120	64		9,5	45
315	1	11	2012	319,6	287	100	16	32	8	
	2	11	2012	"	287	100	28	32	2	
	3	11	2517	"	287	120	40	45	2,5	
	4	12	2517	"	287	120	52		3,5	45
	5	12	2517	"	287	120	64		9,5	45
355	1	11	2012	359,6	326	100	16	32	8	
	2	11	2012	"	326	100	28	32	2	
	3	11	2517	"	326	120	40	45	2,5	
	4	12	2517	"	326	120	52		3,5	45
	5	12	2517	"	326	120	64		9,5	45
400	1	11	2012	404,6	371	112	16	32	8	
	2	11	2517	"	371	125	28	45		
	3	11	2517	"	371	125	40	45		
	4	12	2517	"	371	125	52	45		3,5
	5	12	3020	"	371	158	64	51		6,5
450	1	11	2517	454,6	421	125	16	45	14,5	
	2	11	2517	"	421	125	28	45	8,5	
	3	11	2517	"	421	125	40	45	2,5	
	4	12	3020	"	421	158	52	51		0,5
	5	12	3020	"	421	158	64	51		8,5
500	2	11	2517	504,6	471	125	28	45	8,5	
	3	11	2517	"	471	125	40	45	2,5	
	4	12	3020	"	471	158	52	51		0,5
	5	12	3030	"	471	148	64	76	6	



ETSPA
ETSPA0631

SPA ÉKSZÍJTÁRCSÁK TAPER-LOCK® KÚPOS RÖGZÍTÉSSEL

SPA ékszíjtárcsák							Anyag: Öntöttvas				
Dp osztókör	Horony N	Kivitel	Taper- Lock®	De külső	Di	Dm agy	F	L	P	R	S
63	1	3	1008	69,1	37		20	40		18	22
71	1	4	1108	77,1			20				
	2	5	1108	"	40	62	35	22	2	13	22
	3	5	1108	"			50				
75	1	4	1108	81,1		62	20	22	2		
	2	5	1108	"	44		35			13	22
	3	5	1108	"	44		50			28	22
80	1	4	1210	86,1		75	20	25	5		
	2	5	1210	"	47		35			10	25
	3	5	1210	"	47		50			25	25
85	1	4	1210	91,1		75	20	25	5		
	2	5	1210	"	50		35			10	25
	3	5	1210	"	50		50			25	25
90	1	4	1210	96,1		75	20	25	5		
	2	5	1610	"	60		35			10	25
	3	5	1610	"	60		50			25	25
95	1	4	1210	101,1		75	20	25	5		
	2	5	1610	"	64		35			10	25
	3	5	1610	"	64		50			25	25
	4	7	1615	"	64		65			13,5	38
100	1	4	1610	106,1		80	20	25	5		
	2	5	1610	"	70		35			10	25
	3	6	1610	"	70		50			25	25
	4	6	1615	"	70		65			27	38
	5	6	1615	"	70		80			42	38
106	1	4	1610	112,1		80	20	25	5		
	2	5	1610	"	76		35			10	25
	3	6	1610	"	76		50			25	25
	4	5	2012	"	76		65			33	32
	5	5	2012	"	76		80			48	32
112	1	4	1610	118,1		80	20	25	5		
	2	5	1610	"	80		35			10	25
	3	5	2012	"	80		50			18	32
	4	5	2012	"	80		65			33	32
	5	5	2012	"	80		80			48	32
118	1	4	1610	124,1		80	20	25	5		
	2	5	1610	"	86		35			10	25
	3	6	2012	"	86		50			18	32
	4	6	2012	"	86		65			33	32
	5	6	2012	"	86		80			48	32
125	1	4	1610	131,1		80	20	25	5		
	2	5	1610	"	90		35			10	25
	3	6	2012	"	92		50			18	32
	4	6	2012	"	92		65			33	32
	5	7	2012	"	92		80			24	32



ETSPA
ETSPA1321

SPA ÉKSZÍJTÁRCSÁK TAPER-LOCK® KÚPOS RÖGZÍTÉSSEL

SPA ékszíjtárcsák											Anyag: Öntöttvas	
Dp osztókör	Horony N	Kivitel	Taper- Lock®	De külső	Di	Dm agy	F	L	P	R	S	
132	1	4	1610	138,1		80	20	25	5			
	2	5	2012	"	98		35			3	32	
	3	6	2012	"	98		50			18	32	
	4	6	2517	"	98		65			20	45	
	5	7	2517	"	98		80			17,5	45	
140	1	4	1610	146,1		80	20	25	5			
	2	5	2012	"	106		35			3	32	
	3	5	2517	"	106		50			5	45	
	4	6	2517	"	106		65			20	45	
	5	7	2517	"	106		80			17,5	45	
150	1	4	1610	156,1		80	20	25	5			
	2	5	2012	"	116		35			3	32	
	3	5	2517	"	116		50			5	45	
	4	6	2517	"	116		65			20	45	
	5	7	2517	"	116		80			17,5	45	
160	1	4	1610	166,1		80	20	25	5			
	2	5	2012	"	125		35			3	32	
	3	5	2517	"	126		50			5	45	
	4	6	2517	"	126		65			20	45	
	5	7	2517	"	126		80			17,5	45	
170	1	4	1610	176,1		80	20	25	5			
	2	5	2012	"	135		35			3	32	
	3	5	2517	"	138		50			5	45	
	4	6	2517	"	138		65			20	45	
	5	7	3020	"	138		80			14,5	51	
180	1	4	1610	186,1		80	20	25	5			
	2	9	2012	"	148	100	35			1,5	32	
	3	5	2517	"	146		50			5	45	
	4	6	2517	"	146		65			20	45	
	5	7	3020	"	146		80			14,5	51	
190	1	4	1610	196,1		80	20	25	5			
	2	9	2012	"	158	100	35			1,5	32	
	3	5	2517	"	158		50			5	45	
	4	6	2517	"	158		65			20	45	
	5	7	3020	"	158		80			14,5	51	
200	1	8	2012	206,1	165	100	20	32	12			
	2	10	2517	"	165	120	35	45	5			
	3	9	2517	"	165	120	50			2,5	45	
	4	6	3020	"	165		65			14	51	
	5	7	3020	"	165		80			14,5	51	
212	1	8	2012	218,1	177	100	20	32	12			
	2	10	2517	"	177	120	35	45	5			
	3	9	2517	"	177	120	50			2,5	45	
	4	6	3020	"	177		65			14	51	
	5	7	3020	"	177		80			14,5	51	
224	1	8	2012	230,1	189	100	20	32	12			
	2	8	2517	"	189	120	35	45	10			
	3	9	2517	"	189	120	50			2,5	45	
	4	6	3020	"	189		65			14	51	
	5	6	3020	"	189		80			29	51	
236	1	8	2012	242,1	202	106	20	32	12			
	2	8	2517	"	202	125	35	45	10			
	3	9	2517	"	202	125	50			2,5	45	
	4	9	3020	"	202	146	65			7	51	
	5	9	3020	"	202	155	80			14,5	51	



ETSPA
ETSPA2501

SPA ÉKSZÍJTÁRCSÁK TAPER-LOCK® KÚPOS RÖGZÍTÉSSEL

SPA ékszíjtárcsák							Anyag: Öntöttvas				
Dp osztókör	Horony N	Kivitel	Taper- Lock®	De külső	Di	Dm agy	F	L	P	R	S
250	1	10	2012	256,1	215	100	20	32	6		
	2	10	2517	"	215	120	35	45	5		
	3	9	2517	"	215	120	50			2,5	45
	4	9	3020	"	215	150	65			7	51
	5	9	3020	"	215	150	80			14,5	51
280	1	8	2012	286,1	245	100	20	32	12		
	2	8	2517	"	245	120	35	45	10		
	3	9	2517	"	245	120	50			2,5	45
	4	9	3020	"	245	150	65			7	51
	5	10	3535	"	245	170	80	89	4,5		
300	1	8	2012	306,1	264	112	20	32	12		
	2	8	2517	"	264	125	35	45	10		
	3	10	3020	"	264	146	50	51	0,5		
	4	9	3020	"	264	146	65			7	51
	5	8	3535	"	264	175	80	89	9		
315	1	13	2012	321,1	280	100	20	32	12		
	2	13	2517	"	280	120	35	45	10		
	3	10	3020	"	280	150	50	51	0,5	7	51
	4	9	3020	"	280	150	65				
	5	10	3535	"	280	170	80	89	4,5		
355	1	13	2012	361,1	320	100	20	32	12		
	2	13	2517	"	320	120	35	45	10		
	3	11	3020	"	320	150	50	51	0,5	7	51
	4	12	3020	"	320	150	65				
	5	11	3535	"	320	170	80	89	4,5		
400	1	13	2012	406,1	365	100	20	32	12		
	2	13	2517	"	365	120	35	45	10		
	3	11	3020	"	365	150	50	51	0,5	7	51
	4	12	3020	"	365	150	65				
	5	11	3535	"	365	170	80	89	4,5		
450	1	13	2012	456,1	415	100	20	32	12		
	2	13	2517	"	415	120	35	45	10		
	3	11	3020	"	415	150	50	51	0,5	7	51
	4	12	3020	"	415	150	65				
	5	11	3535	"	415	170	80	89	4,5		
500	1	13	2517	506,1	465	120	20	45	25		
	2	13	2517	"	465	120	35	45	10		
	3	11	3020	"	465	150	50	51	0,5	7	51
	4	12	3020	"	465	150	65				
	5	11	3535	"	465	170	80	89	4,5		
630	2	13	3020	636,1	595	150	35	51	16		
	3	11	3020	"	595	150	50	51	0,5		
	4	11	3535	"	595	170	65	89	12		
	5	11	3535	"	595	170	80	89	4,5		
	6	11	4040	"	595	200	95	102	3,5		
800	3	11	3535	806,1	765	170	50	89	19,5		
	4	11	3535	"	765	170	65	89	12		
	5	11	4040	"	765	200	80	102	11		



ETSPB
ETSPB1001

SPB ÉKSZÍJTÁRCSÁK TAPER-LOCK® KÚPOS RÖGZÍTÉSSEL

SPB ékszíjtárcsák							Anyag: Öntöttvas				
D _p osztókör	Horony N Kivitel	Taper- Lock®	De külső	Di	Dm agy	F	L	P	R	S	
100	1	1	1610	107,6		25					
	2	6	1610	"	57	44			19	25	
106	1	1	1610	113,6		25					
	2	6	1610	"	67	44			19	25	
	3	6	1610	"	67	63			38	25	
112	1	1	1610	119,6		25					
	2	6	1610	"	72	44			19	25	
	3	6	1610	"	72	63			38	25	
118	1	1	1610	125,6		25					
	2	6	1610	"	78	44			19	25	
	3	6	1610	"	78	63			38	25	
125	1	1	1610	132,6		25					
	2	6	2012	"	82	44			12	32	
	3	6	2012	"	82	63			31	32	
	4	7	2012	"	82	82			25	32	
	5	5/6	2012	"	82	101			69	32	
132	1	1	1610	139,6		25					
	2	6	2012	"	89	44			12	32	
	3	6	2012	"	89	63			31	32	
	4	7	2012	"	89	82			25	32	
	5	5	2517	"	89	101			56	45	
140	1	1	1610	147,6		25					
	2	6	2012	"	97	44			12	32	
	3	6	2012	"	97	63			31	32	
	4	7	2517	"	97	82			18,5	45	
	5	7	2517	"	97	101			28	45	
	6	7	2517	"	97	120			37,5	45	
	7	7	2517	"	97	158			56,5	45	
	8	7	2517	"	97						
150	1	1	1610	157,6		25					
	2	6	2012	"	107	44			12	32	
	3	6	2517	"	107	63			18	45	
	4	7	2517	"	107	82			18,5	45	
	5	7	2517	"	107	101			28	45	
	6	7	2517	"	107	120			37,5	45	
160	1	1	1610	167,6		25					
	2	6	2012	"	117	44			12	32	
	3	6	2517	"	117	63			18	45	
	4	7	2517	"	117	82			18,5	45	
	5	7	2517	"	117	101			28	45	
	6	7	3020	"	117	120			34,5	51	
	7	7	3020	"	117	158			53,5	51	
	8	7	3020	"	117						
170	1	1	1610	177,6		25					
	2	6	2012	"	127	44			12	32	
	3	6	2517	"	127	63			18	45	
	4	7	2517	"	127	82			18,5	45	
	5	7	3020	"	127	101			25	51	
	6	7	3020	"	127	120			34,5	51	
180	1	14	1610	187,6	137	80	25				
	2	4	2517	"		120	44	45	1		
	3	6	2517	"	137		63			18	
	4	7	2517	"	137		82			18,5	
	5	7	3020	"	137		101			25	
	6	7	3020	"	137		120			34,5	
	7	7	3020	"	137		158			41	
	8	7	3030	"	137					76	



ETSPB
ETSPB1901

SPB ÉKSZÍJTÁRCSÁK TAPER-LOCK® KÚPOS RÖGZÍTÉSSEL

SPB ékszíjtárcsák											Anyag: Öntöttvas	
D _p osztókör	Horony N	Kivitel	Taper- Lock®	De külső	Di	Dm agy	F	L	P	R	S	
190	1	10	2012	197,6	147	100	25	32	3,5 1	18 18,5 25 34,5 41	45 45 51 51 76	
	2	4	2517	"		120	44	45				
	3	6	2517	"	147		63					
	4	7	2517	"	147		82					
	5	7	3020	"	147		101					
	6	7	3020	"	147		120					
	7	7	3030	"	147		158					
	8	7	3030	"	147		158					
200	1	10	2012	207,6	157	100	25	32	3,5 1	18 15,5 25 34,5 34,5	45 51 51 51 89	
	2	4	2517	"		120	44	45				
	3	6	2517	"	157		63					
	4	6/7	3020	"	157		82					
	5	7	3020	"	157		101					
	6	7	3020	"	157		120					
	7	7	3020	"	157		120					
	8	7	3535	"	161		158					
212	1	10	2012	219,6	169	100	25	32	3,5 1	18 15,5 25 15,5 34,5	45 51 51 89 89	
	2	8	2517	"	169	120	44	45				
	3	15	2517	"	169	120	63					
	4	7	3020	"	169		82					
	5	7	3020	"	169		101					
	6	7	3535	"	169		120					
	7	7	3535	"	169		120					
	8	7	3535	"	173		158					
224	1	10	2012	231,6	181	100	25	32	3,5 1	18 15,5 25 15,5 34,5	45 51 51 89 89	
	2	8 _a	2517	"	181	120	44	45				
	3	15	2517	"	181	120	63					
	4	6/7	3020	"	181		82					
	5	7	3020	"	181		101					
	6	7	3535	"	181		120					
	7	7	3535	"	181		120					
	8	7	3535	"	185		158					
236	1	10	2012	243,6	193	100	25	32	3,5 1	18 15,5 6 15,5 34,5	45 51 89 89 89	
	2	8 _a	2517	"	193	120	44	45				
	3	15	2517	"	193	120	63					
	4	7	3020	"	193		82					
	5	7	3535	"	193		101					
	6	7	3535	"	193		120					
	7	7	3535	"	193		120					
	8	7	3535	"	197		158					
250	1	10	2012	257,6	207	100	25	32	3,5 1	12 15,5 6 15,5 34,5	51 51 89 89 89	
	2	8 _a	2517	"	207	120	44	45				
	3	15	3020	"	207	150	63					
	4	9	3020	"	207	150	82					
	5	7	3535	"	207		101					
	6	7	3535	"	207		120					
	7	7	3535	"	207		120					
	8	7	3535	"	207		158					
280	1	10	2012	287,6	237	100	25	32	3,5 1	6 15,5 6 15,5 34,5	51 51 89 89 89	
	2	8 _a	2517	"	237	120	44	45				
	3	9	3020	"	237	150	63					
	4	9	3020	"	237	150	82					
	5	9	3535	"	237	170	101					
	6	9	3535	"	237	170	120					
	7	9	3535	"	237	170	120					
	8	9	3535	"	237	175	158					
300	1	10	2012	307,6	257	100	25	32	3,5 1	6 15,5 6 15,5 34,5	51 51 89 89 89	
	2	8 _a	2517	"	257	120	44	45				
	3	9	3020	"	257	150	63					
	4	9	3020	"	257	150	82					
	5	9	3535	"	257	170	101					
	6	9	3535	"	257	170	120					
	7	9	3535	"	257	170	120					
	8	9	3535	"	257	170	158					



ETSPB
ETSPB3151

SPB ÉKSZÍJTÁRCSÁK TAPER-LOCK® KÚPOS RÖGZÍTÉSSEL

SPB ékszíjtárcsák				Anyag: Öntöttvas									
Dp Osztókör	Horony N	Taper- Kivitel	Taper- Lock®	De külső	Di	Dm agy	F	L	P	R	S	T	
315	1	10	2012	322,6	272	100	25	32	3,5				
	2	8 _a	2517	"	272	120	44	45	1				
	3	9	3020	"	272	150	63				51		
	4	10	3535	"	272	170	82	89	3,5	6			
	5	9	3535	"	272	170	101			6		89	
	6	9	3535	"	272	170	120			15,5		89	
	8	9	3535	"	272	175	158			34,5		89	
	335	2	8 _a	2517	342,6	292	120	44	45	1			
3		9	3020	"	292	150	63				51		
4		10	3535	"	292	170	82	89	3,5	6			
5		9	3535	"	292	170	101			6		89	
6		9	3535	"	292	170	120			15,5		89	
8		9	3535	"	292	175	158			34,5		89	
355		2	11	3020	362,6	312	150	44	51	3,5			
		3	12	3020	"	312	150	63				51	
	4	10	3535	"	312	170	82	89	3,5	6			
	5	12	3535	"	312	170	101			6		89	
	6	9	3535	"	312	170	120			15,5		89	
	8	9	3535	"	312	170	158			34,5		89	
	400	2	11	3020	407,6	357	150	44	51	3,5			
		3	11	3535	"	357	170	63	89	13			
4		11	3535	"	357	170	82	89	3,5				
5		12	3535	"	357	170	101			6		89	
6		12	3535	"	357	170	120			15,5		89	
8		12	4040	"	357	200	158			28		102	
450		2	11	3020	457,6	407	150	44	51	3,5			
		3	13	3535	"	407	170	63	89	26			
	4	13	3535	"	407	170	82	89	7				
	5	16	3535	"	407	170	101			12		89	
	6	16	4040	"	407	200	120			18		102	
	8	12	4040	"	407	200	158			28		102	
	500	2	11	3020	507,6	457	150	44	51	3,5			
		3	13	3535	"	457	170	63	89	26			
4		13	3535	"	457	170	82	89	7				
5		16	3535	"	457	170	101			12		89	
6		16	4040	"	457	200	120			18		102	
8		12	4040	"	457	200	158			28		102	
560		2	17	3030	567,6	517	150	44	76	28			
		3	13	3535	"	517	170	63	89	26			4
	4	13	3535	"	517	170	82	89	7				
	5	13	4040	"	517	200	101	102	1				
	6	16	4040	"	517	200	120			18		102	
	8	12	4545	"	517	225	158			22		114	
	630	3	13	3535	637,6	587	170	63	89	26			
		4	13	3535	"	587	170	82	89	7			
5		13	4040	"	587	200	101	102	1				
6		16	4040	"	587	200	120			18		102	
8		12	4545	"	587	225	158			22		114	
710		3	17	3535	717,6	664	170	63	89	22			
		4	11	3535	"	664	170	82	89	3,5			4
		5	11	4040	"	664	200	101	102	0,5			
	6	12	4545	"	664	225	120			3		114	
	8	12	4545	"	664	225	158			22		114	
	10	12	4545	"	664	225	196			41		114	
	800	3	17	3535	807,6	754	170	63	89	22			
		4	17	4040	"	754	200	82	102	16			4
5		11	4040	"	754	200	101	102	0,5			4	
6		12	4545	"	754	225	120			3		114	
8		12	4545	"	754	225	158			22		114	
10		12	4545	"	754	225	196			41		114	
1000		3	17	4040	1007,6	954	200	63	102	33			
		4	17	4040	"	954	200	82	102	16			6
	5	11	4545	"	954	225	101	114	6,5			4	
	6	12	4545	"	954	225	120			3		114	
	8	12	5050	"	954	245	158			15,5		127	
	10	12	5050	"	954	245	196			34,5		127	
	1250	4	11	4545	1257,6	1204	225	82	114	16			
		5	11	4545	"	"	225	101	114	16			
6		11	5050	"	"	245	120	127	3,5				
8		12	5050	"	"	245	158			15,5		127	
10		12	5050	"	"	245	196			34,5		127	



ETSPC
ETSPC2002

SPC ÉKSZÍJTÁRCSÁK TAPER-LOCK® KÚPOS RÖGZÍTÉSSEL

SPC ékszíjtárcsák												Anyag: Öntöttvas	
Dp	Horony		Taper-	De	Di	Dm	F	L	P	R	S	T	
Osztókör	N	Kivitel	Lock®	külső		agy							
200	2	6	2517	210,2	144		65			20	45		
	3	7	2517	"	144		85			20	45		
	4	7	3020	"	144		111			30	51		
	5	7	3535	"	144		136			23,5	89		
	6	7	3535	"	144		162			36,5	89		
	8	7	3535	"	144		213			62	89		
224	2	6	3020	234,2	173		68			17	51		
	3	7	3020	"	173		85			17	51		
	4	7	3535	"	173		111			11	89		
	5	7	3535	"	173		136			23,5	89		
	6	7	3535	"	173		162			36,5	89		
	8	7	3535	"	170		213			62	89		
250	2	6	3020	260,2	198		68			17	51		
	3	7	3020	"	198		85			17	51		
	4	7	3535	"	198		111			11	89		
	5	7	3535	"	198		136			23,5	89		
	6	7	3535	"	198		162			36,5	89		
	8	7	3535	"	198		213			62	89		
280	2	4	3535	290,2		170	59,5	89	29,5				
	3	4	3535	"		170	85	89	4				
	4	7	3535	"	228		111			11	89		
	5	7	3535	"	228		136			23,5	89		
	6	7	3535	"	228		162			36,5	89		
	8	7	3535	"	228		213			62	89		
10	7	4040	"	222		264			81	102			
300	3	10	3535	310,2	247	170	85	89	2				
	4	9	3535	"	247	170	111			11	89		
	5	9	3535	"	247	170	136			23,5	89		
	6	9	3535	"	247	170	162			36,5	89		
	8	7	4040	"	247		213			55,5	102		
	10	7	4545	"	242		264			75	114		
315	2	8	3535	325,2	264	170	59,5	89	27,5				
	3	10	3535	"	264	170	85	89	2				
	4	9	3535	"	264	170	111			11	89		
	5	9	3535	"	264	170	136			23,5	89		
	6	9	3535	"	264	170	162			36,5	89		
	8	7	4040	"	258	170	213			55,5	102		
10	7	4545	"	258		264			75	114			
335	2	8	3535	345,2	279	170	59,5	89	29,5				
	3	10	3535	"	279	170	85	89	2				
	4	9	3535	"	279	170	111			11	89		
	5	9	3535	"	279	170	136			23,5	89		
	6	9	3535	"	279	170	162			36,5	89		
	8	9	4040	"	279	200	213			55,5	102		
10	7	4545	"	279		264			75	114			
355	2	8	3535	365,2	304	170	59,5	89	27,5				
	3	10	3535	"	304	170	85	89	2				
	4	9	3535	"	304	170	111			11	89		
	5	9	3535	"	304	170	136			23,5	89		
	6	9	3535	"	304	170	162			36,5	89		
	8	7	4040	"	304		213			55,5	102		
10	7	4545	"	299		264			75	114			
400	2	17	3535	410,2	344	170	59,5	89	27,5			2	
	3	11	3535	"	344	170	85	89	2			89	
	4	12	3535	"	344	170	111			11	89		
	5	12	3535	"	344	170	136			23,5	102		
	6	9	4040	"	348	200	162			30	114		
	8	12	4545	"	348	225	213			49,5	117		
10	7	5050	"	342		264			68,5	127			

ETSPC
ETSPC4502

SPC ÉKSZÍJTÁRCSÁK

TAPER-LOCK® KÚPOS RÖGZÍTÉSSEL

SPC ékszíjtárcsák										Anyag: Öntöttvas		
Dp	Horony	Taper-	De	Di	Dm	F	L	P	R	S	T	
Osztókör	N	Kivitel	Lock®	külső	agy							
450	2	17	3535	460,2	394	170	59,5	89	27,5		2	
	3	11	3535	"	394	170	85	89	2			
	4	12	3535	"	394	170	111			11	89	
	5	12	4040	"	394	200	136			17	102	
	6	9	4545	"	394	225	162			24	114	
	8	9	5050	"	394	245	213			43	127	
	10	9	5050	"	394	245	264			68,5	127	
475	2	17	3535	485,2	419	170	59,5	89	27,5		2	
	3	11	3535	"	419	170	85	89	2			
	4	12	3535	"	419	170	111			11	89	
	5	12	4040	"	419	200	136			17	102	
	6	12	4545	"	419	225	162			24	114	
	8	12	5050	"	419	245	213			43	127	
	10	9	5050	"	419	245	264			68,5	127	
500	2	17	3535	510,2	444	170	59,5	89	27,5		2	
	3	11	3535	"	444	170	85	89	2			
	4	12	3535	"	444	170	111			11	89	
	5	12	4040	"	444	200	136			17	102	
	6	12	4545	"	444	225	162			24	114	
	8	9	5050	"	444	245	213			43	127	
	10	9	5050	"	444	245	264			68,5	127	
560	2	17	3535	570,2	504	170	59,5	89	27,5		2	
	3	11	3535	"	504	170	85	89	2			
	4	12	4040	"	504	200	111			4,5	102	
	5	12	4545	"	504	225	136			11	114	
	6	12	5050	"	504	245	162			17,5	127	
	8	12	5050	"	504	245	213			43	127	
	10	9	5050	"	504	245	264			68,5	127	
630	2	17	4040	640,2	574	200	59,5	102	34		8,5	
	3	11	4040	"	574	200	85	102	8,5			
	4	11	4545	"	574	225	111	114	1,5			
	5	12	5050	"	574	245	136			4,5	127	
	6	12	5050	"	574	245	162			17,5	127	
	8	12	5050	"	574	245	213			43	127	
	10	9	5050	"	574	245	264			68,5	127	
710	4	17	5050	720,2	654	267	111	127	12		4	
	5	12	5050	"	654	245	136			4,5	127	
	6	12	5050	"	654	245	162			17,5	127	
	8	12	5050	"	654	245	213			43	127	
	10	12	5050	"	654	245	264			68,5	127	
800	4	17	5050	810,2	737	245	111	127	12		4	
	5	12	5050	"	737	245	136			4,5	127	
	6	12	5050	"	737	245	162			17,5	127	
	8	12	5050	"	737	245	213			43	127	
	10	12	5050	"	737	245	264			68,5	127	
1000	4	17	5050	1010,2	937	245	111	127	12		4	
	5	12	5050	"	937	245	136			4,5	127	
	6	12	5050	"	937	245	162			17,5	127	
	8	12	5050	"	937	245	213			43	127	
	10	12	5050	"	937	245	264			68,5	127	
1250	5	12	5050	1260,2	1187	245	136			4,5	127	
	6	12	5050	"	1187	245	162			17,5	127	
	8	12	5050	"	1187	245	213			43	127	
	10	12	5050	"	1187	245	264			68,5	127	

A táblázatban megadott SPZ-SPA-SPB-SPC ékszíjtárcsák és kúpos perselyek méretei nem kötelezőek, de tiszteletben kell tartani.

Módosítás és változtatás jogát fenntartjuk.